



# 2026 Owner's Manual

## Purfikt™ Series

Coast Spas Manufacturing  
6315 202 Street | Langley, BC Canada V2Y 1N1  
info@coastspas.com | www.coastspas.com



**CONGRATULATIONS!**

**YOU'RE ALMOST READY TO ENJOY YOUR NEW SPA!**

Before you begin to enjoy your spa, please take a moment to submit your spa warranty. For registering your spa, you will need the spa serial number. Picture below will help you locate the serial number on your spa.



You can register your spa by using below link.

<https://coastspas.microsoftcrmportals.com/>

**FOR YOUR REFERENCE**

Spa owner name: \_\_\_\_\_

Address: \_\_\_\_\_

Contact: \_\_\_\_\_

Email: \_\_\_\_\_

Spa Serial number: \_\_\_\_\_

Purchase Date: \_\_\_\_\_

Delivery Date: \_\_\_\_\_

Dealer Name: \_\_\_\_\_

Contact your spa selling dealer if you have any queries related to your Purfikt spa. Coast Spas authorized dealers are trained professionals who can assist you with spa parts, setup, operations, maintenance, and technical support.

**DISCLAIMER:** At the time of print, this manual is accurate in its information. Coast Spas reserves all the rights to change/modify any spa designs and/or features without notification. To check on updates or for other information, please visit [www.coastspas.com](http://www.coastspas.com)

## TABLE OF CONTENTS

<b>Registering your Purfikt spa</b>	<i>Page</i>	<b>2</b>
<b>Table of contents</b>	<i>Page</i>	<b>3</b>
<b>Basic information</b>	<i>Page</i>	<b>4</b>
<b>Important safety instructions</b>	<i>Page</i>	<b>5-6</b>
<b>Glossary of terms</b>	<i>Page</i>	<b>6-7</b>
<b>Preparation, set-up and location of your new spa</b>	<i>Page</i>	<b>7-8</b>
<b>Purfikt spa general layout</b>	<i>Page</i>	<b>9</b>
<b>Purfikt Spa Collection</b>	<i>Page</i>	<b>10</b>
<b>Purfikt Spa features and specifications</b>	<i>Page</i>	<b>11</b>
<b>Start Up Guide— Purfikt Spas</b>	<i>Page</i>	<b>12</b>
<b>Purfikt Spa Care Guide</b>	<i>Page</i>	<b>13-14</b>
<b>Basic installation and configuration guidelines : Electrical requirements</b>	<i>Page</i>	<b>14-15</b>
<b>Purfikt Spa maintenance procedures</b>	<i>Page</i>	<b>16-17</b>
<b>Coast Spas chemicals</b>	<i>Page</i>	<b>18-19</b>
<b>Water clarity troubleshooting</b>	<i>Page</i>	<b>20</b>
<b>Troubleshooting guide</b>	<i>Page</i>	<b>21-22</b>
<b>Draining &amp; Winterizing</b>	<i>Page</i>	<b>23</b>
<b>Purfikt Spa Controls</b>	<i>Page</i>	<b>24</b>
<b>ControlMySpa</b>	<i>Page</i>	<b>25-28</b>
<b>Balboa Wi-Fi module</b>	<i>Page</i>	<b>29</b>
<b>Balboa Ultrazone operation</b>	<i>Page</i>	<b>29</b>
<b>Coast Spas EcoClean UV and Sanitizer</b>	<i>Page</i>	<b>30</b>
<b>Purfikt Spa service log</b>	<i>Page</i>	<b>28-29</b>



PLEASE READ YOUR ENTIRE OWNER'S MANUAL BEFORE SPA OPERATION



## Basic Information

### Water Care

**IMPORTANT:** Caring for your water by ensuring proper chemical usage is the single most important thing you can do to keep your Purfikt spa in good condition.

**WARNING:** Improper chemical usage and maintenance will quickly lead to severe issues with your spa and can effect the spa equipment, jets, pumps, and all other components in contact with the spa water.

All spas are susceptible to damage from unbalanced spa water.

Always maintain your water chemistry within the following parameters.

pH	7.2 - 7.8
Chlorine	1.0 - 3.0 ppm
Bromine	2.0 - 5.0 ppm
Total Alkalinity	100 - 120 ppm
Calcium Hardness	150 - 250 ppm

### Electrical

All self contained spas use 120VAC or 240VAC electrical spa packs.

**120VAC:** requires an isolated 15 Amp circuit breaker, an isolated circuit with no other appliances or lights on the circuit at any time. Extension cords are not to be used in conjunction with the operations of the spa. Low voltage damage could result and this is not covered under warranty.

**IMPORTANT:** spas with 110V means that the jets and heater will not work at the same time.

**Note:** All components must be 120V. No 240V components allowable.

**240VAC:** Depending on the model of the spa, it will require either a 40, 50, or 60 Amp dedicated circuit breaker with the proper wire size (gauge) based on the length of the run.

The electrical circuit must be installed by a certified electrician and approved by a local building or electrical inspector.

### Surface

Your new portable spa must be placed on a solid, level surface so that the weight is supported uniformly. We recommend no less than a 3" (93 mm) thick concrete slab. Wood decking or balconies must be constructed to support 150 pounds per square foot (730 kg/m<sup>2</sup>). Refer to the local and current building codes in your area. Should your new spa need to go through the gate or space –restricted area, ensure you've communicated those limitations with your dealer to avoid delivery complications.

**NOTE:** Damage caused by alternate decking methods may void the spa warranty. Contact your dealer if you have any questions regarding spa location and placement.

### Transport

Your new spa has left the factory cleaned and polished and ready to begin operation after passing our many quality and operational tests. However, depending on your location in the world, your spa may have spend days or even weeks in transit before arriving at your home. Please ensure that before filling or operating your spa that you check all electrical and plumbing connections are securely connected in the equipment area as they might have loosened during shipping. If any dirt has accumulated, you will want to remove with a clean cloth or sponge using warm water.

## IMPORTANT SAFETY INSTRUCTIONS

### READ AND FOLLOW ALL INSTRUCTIONS CAREFULLY

**DANGER:** Risk of Injury. The suction fittings in the Purfikt spa are sized to match the specific water flow created by the pump. Should the need arise to replace the suction fittings or the pump, be sure that the flow rates are compatible. Never operate the spa if the suction fittings are broken or missing. Never replace a suction fitting with one rated less than the flow rate marked on the original suction fitting.

**DANGER:** Risk of Accidental Drowning. Do not allow children to be in or around the spa without adult supervision. Keep the Purfikt spa cover on and locked when not in use. See instructions enclosed with the cover for locking procedures.

**DANGER:** Risk of Electrical Shock. The electrical supply for this product must include a suitably rated switch or circuit breaker to open all ungrounded supply conductors to comply with section 422-20 of the National Electrical Code, ANSI/NFPA 70. The disconnect must be readily accessible and visible to the spa occupant but installed at least 5 feet (1.5 m) from the Purfikt spa water.

### READ, FOLLOW AND SAVE THESE INSTRUCTIONS

- a) A green colored terminal or a terminal marked G, Gr, Ground, Grounding or the symbol \* is located inside the supply terminal box or compartment. To reduce the risk of electric shock, this terminal must be connected to the grounding means provided in the electric supply service panel with a continuous copper wire equivalent in size to the circuit conductors that supply this equipment.
- b) At least two lugs marked "Bonding Lugs" are provided on the external surface or on the inside of the supply terminal box compartment. To reduce the risk of electric shock, connect the local common bonding grid in the area of the spa to these terminals with an insulated or bare copper conductor not smaller than No. 6 AWG.
- c) All field-installed metal components such as rails, ladders, drains or other similar hardware within 5 feet (1.5 m) of the spa shall be bonded to the equipment grounding buss with copper conductors not smaller than No. 6 AWG.

**WARNING: To Reduce the Risk of Injury:** The water in a spa should never exceed 104 °F (40 °C). Water temperatures between 100 °F (38 °C) and 104 °F (40 °C) are considered safe for a healthy adult. Lower water temperatures are recommended for young children and

when spa use exceeds 10 minutes. Since excessive water temperatures have a high potential for causing fetal damage during the early months of pregnancy, pregnant or possibly pregnant women should limit spa water temperatures to 100 °F (38 °C). If pregnant, please consult your physician before using a spa. Before entering the spa, the user should measure the water temperature with an accurate thermometer since the tolerance of water temperature regulating devices may vary as much as +/- 5 °F (2 °C). Persons suffering from obesity or a medical history of heart disease, low or high blood pressure, circulatory system problems or diabetes should consult a physician before using the spa.

**CAUTION: Risk of Hyperthermia:** Hyperthermia occurs when the internal temperature of the body reaches a level several degrees above the normal body temperature of 98.6 °F (37°C). The symptoms of hyperthermia include drowsiness, lethargy, and an increase in the internal temperature of the body. Prolonged immersion in hot water may induce hyperthermia. A description of the causes, symptoms, and effects of hyperthermia are as follows:

- Unawareness of impending hazard;
- Failure to perceive heat;
- Failure to recognize the need to exit spa;
- Physical inability to exit spa;
- Fetal damage in pregnant women; and
- Unconsciousness and danger of drowning.

**WARNING:** Children should not use the spa without adult supervision.

**WARNING:** Do not use the spa unless all suction guards are installed to prevent body and hair entrapment.

**WARNING:** People with infectious diseases should not use a spa.

**WARNING:** To avoid injury, exercise care when entering or exiting the spa.

**WARNING:** Do not use drugs or alcohol before or during the use of a spa to avoid unconsciousness and possible drowning. The use of alcohol or drugs can greatly increase the risk of fatal hyperthermia in spas.

**WARNING:** Pregnant or possibly pregnant women should consult a physician before using a spa.

**WARNING:** Water temperature in excess of 38 °C (100 °F) may be injurious to your health. Before entering the

spa, measure the water temperature with an accurate thermometer.

**WARNING:** Do not use the spa immediately following strenuous exercise.

**WARNING:** Prolonged immersion in a spa may be injurious to your health.

**WARNING:** Do not permit electric appliances (such as lights, telephone, radio, television, etc.) within 5 feet (1.5m) of the spa unless such appliances are built-in by the manufacturer.

**WARNING:** People using medication and/or having an adverse medical history should consult a physician before using a spa.

**WARNING:** To avoid injury, exercise care when entering or exiting the spa.

**WARNING:** Maintain water chemistry in accordance with the manufacturer's instructions.

**WARNING:** The equipment and controls shall be located no less than 1.5 meters horizontally from the spa.

**CAUTION:** Observe a reasonable time limit when using the spa. Long exposures at higher temperatures can cause high body temperature. Symptoms may include dizziness, nausea, fainting, drowsiness, and reduced awareness. These effects could possibly result in drowning.

**CAUTION:** Enter and exit the spa slowly. Wet surfaces can be very slippery.

**CAUTION:** Proper chemical maintenance of spa water is necessary to maintain safe water and prevent possible damage to spa components. Maintain water chemistry in accordance with manufacturer's instructions.

**CAUTION:** Use the straps and clip tie downs to secure the cover when not in use. This will help to discourage unsupervised children from entering the spa and keep the spa cover secure in

high-wind conditions. There is no representation that the cover, clip tie-downs, or actual locks will prevent access to the spa.

**CAUTION:** For exercise, the water should not exceed 90 °F (32 °C).

## GLOSSARY OF TERMS



**AIR CONTROL:** Mounted generally on the lip of the spa, it induces warm air from the equipment enclosure into the jet stream through venturi action.



**WATER DIVERTER:** The large diverter is used to divert water to various seats in the spa.



**FILTER AIR RELIEF VALVE:** Located on top of filter housing. Used to release air from the filter.



**SKIMMER BLEEDER VALVE:** Located inside the skimmer area or on the spa wall, needs to be loosened while filling the spa. This will help eliminate air from being trapped in the spa equipment.



**OZONATOR:** Available as an option. The ozonator produces natural ozone through the Corona Discharge process. Continuous use of an ozonator can dramatically reduce sanitizer consumption.



**CONTROL BOX (PACK):** Basically the "heart" of the spa. Power is distributed to any/all functions of the spa: pumps, ozonator, LED lighting, heater element, etc.



**FUSION TOUCHSCREEN CONTROL** beautifully recessed into the spa acrylic and accented with a brushed metal band that borders the edge of the color touchscreen panel.



**EQUIPMENT ENCLOSURE:** An enclosure that houses the control box, pump(s) and other electrical components.

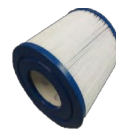

**FILTER:** The filter cleans the spa by passing water through a filter cartridge where debris and impurities are removed. Top load filter means the filter cartridge is accessible through the top of the spa. Front access skimmer means cartridge is accessed through door of skimmer.

**DISCLAIMER:** The pictures displayed above are for reference purpose only. Some parts may be different depending upon the spa model.



**FLOOR DRAIN:** The floor drain is covered by a grate-type cover and is utilized when draining the spa. It also acts as the return for the ozonator. You will see bubbles emitted from this drain, which is the result of water mixing with the ozone output.



**GATE VALVES:** Red with a grey handle is located at the inlet and outlet of the pumping system. Used while servicing the spa equipment, the valves open or close the water flow to the equipment. To remain open for normal use, turn fully counterclockwise.



**KNIFE VALVES:** A white "T"-handled valve, same functions as Gate valve (see above), except to open them you pull up on handle.



**HEATER:** The electronically controlled heater raises the temperature of the spa to the desired setting.



**LEDs** and their special lenses can be used to achieve the desired mood lighting in the spa and spa jets.

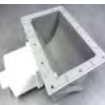

**SKIMMER:** This is the rectangular outlet at the water level. The skimmer removes surface debris to the filter. The water level in the spa should be kept  $\frac{1}{2}$  to  $\frac{3}{4}$  up on the skimmer for optimum operation.



**SUCTION:** During operation of the equipment, the suction works in conjunction with the skimmer to draw water from the bottom of the spa through the filter, keeping the spa sparkling clean.



**ADJUSTABLE CLUSTER JET:** Our adjustable, high-intensity hydrotherapy jet.



**VOLCANO JET:** high-output jet designed for foot and leg massage.



**FUSION JETS:** Coast Spas' Fusion Jets provide a seamless and smooth surface to relax against while you enjoy a therapeutic massage from various jet types all positioned to maximize hydrotherapy.



**Digital Float and Fill Gauge:** The illuminated fill gauge for all Cascade Series Spas takes the guesswork out of filling the overflow tank.

## PREPARATION, SET-UP AND LOCATION FOR YOUR NEW SPA:

- You want to keep in mind how you intend to use the spa and plan the location accordingly.
- How close is the spa from the exit or entrance to your house? (consider the cold weather)
- Is the path to your spa clean of debris, sand, grass? (so as not to track into the spa).
- Is there protection from wind, inclement weather?
- Can neighbors or passersby see the spa?

**NOTE: Allow for service access:** Many spa owners enjoy placing their spa in a decorative enclosure or a deck. Keep in mind that you need to have access to the equipment for maintenance and the spa should be able to be moved or lifted without destroying the special enclosure or its surroundings. You should discuss this with your dealer when designing the location. Extension cords are not to be used in conjunction with the operations of the spa. Low voltage damage could result and this is not covered by warranty.

**IMPORTANT:** For spas or hot tubs installed indoors, care should be taken to ensure adequate ventilation for the indoor space to avoid undesired buildup of humidity due to spa water. For additional information on ventilation and humidity guidelines, see the ASHRAE Handbook – HVAC Applications, I-P Edition, Sections 4.5, 4.6, and 4.7.

**DISCLAIMER:** The pictures displayed above are for reference purpose only. Some parts may be different depending upon the spa model.



## PURFIKT SPA - SAFE HANDLING / UNLOADING INSTRUCTIONS

# CAUTION!



- Use 6" wide straps that are at least 30 feet in length to support the base of the spa during lifting.
- Ensure the straps are in good working condition prior to unloading the spa (ie. No rips, wear or tear)
- Add an Insert Support (see diagram below). In-place them along the straps to prevent the Lightbox during lift.
- Ensure the straps & inserts are evenly spaced at 12" from each end (see diagram below). Spacing the straps may require slight adjustments to ensure the load is balanced.
- The chains attached to the crane must be a minimum of 18 feet in length from the point of lifting. Using chains smaller than 18 feet will add stress to the outer lip of the spa and may result in damage.
- Using the appropriately weighted straps and chains is important to ensure the safe handling of the PURFIKT Spa. Please consult your crane operator for more information.

**Note:** Damage during transportation or from mishandling or improper lifting is not covered by the CSMI Warranty.

**Note:** Never lift or handle the spa by the plumbing or equipment.

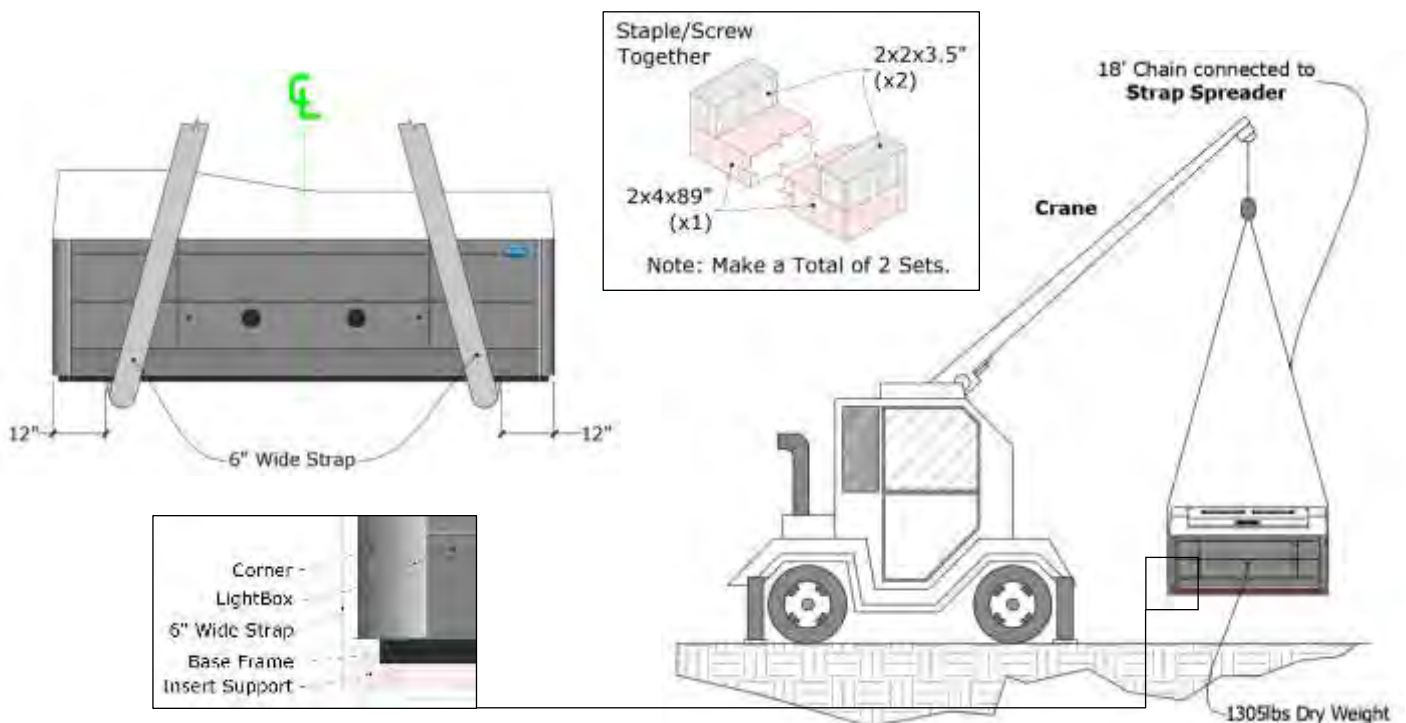

## PURFIKT SPA GENERAL LAYOUT (Your Purfikt spa may look different)



1. Hydro Cyclonic Water Filtration System
2. Fusion Touchscreen Control Panel
3. Air Controls & Water Diverter
4. 24" Fusion Waterfall
5. Fusion Jets
6. Poly Jet
7. Cluster Jets
8. Waterfall Shutoff valves
9. Floor Drain
10. Suctions
11. Volcano Jet
12. Ozone Cluster
13. 5" Spa Light
14. Skimmers
15. Spa LED
16. Air Relief

**DISCLAIMER:** The pictures displayed above are for reference purpose only. Some parts may be different depending upon the spa model.

**DISCLAIMER:** At the time of print, this manual is accurate in its information. Coast Spas reserves all the rights to change/modify any spa designs and/or features without notification. To check on updates or for other information, please visit [www.coastspas.com](http://www.coastspas.com)

## PURFIKT SPA COLLECTION



Purfikt Infinity



2 Purfikt Infinity



2 Purfikt

**DISCLAIMER:** The pictures displayed above are for reference purpose only. Some parts may be different depending upon the spa model.

**DISCLAIMER:** At the time of print, this manual is accurate in its information. Coast Spas reserves all the rights to change/modify any spa designs and/or features without notification. To check on updates or for other information, please visit [www.coastspas.com](http://www.coastspas.com)

## THE PURFIKT SPA INCLUDES

*Choose model to see specific features and options. All features below may not be included with all models.*



**Color Touch Screen Controls:** This easy-to-use control panel features a large multilingual color LCD interface with intuitive icons and animations. There are no buttons to press, just touch the feature you want to control on the touch sensitive screen.



**Patented Technology and Design:** Always Perfect. In a Coast Spas Purfikt Series Spa, the water level will always stay the same regardless of how many people are in the Spa.



**Volcano Jet:** Extremely powerful and therapeutic. The Coast Spas Volcano Jet is installed near the bottom of the Spa and points upward to the surface.



**Largest Skimmers:** Coast spas is proud to offer the largest skimmer in the industry, this allows our Spas to remove debris from the surface of the Spa and help to control foaming.



**Fusion Jets:** New Ultra Flush Jets. Fused flush to the acrylic, Coast Spas' Fusion Jets provide a seamless and smooth surface to relax against while you enjoy a therapeutic massage from various jet types all positioned to maximize hydrotherapy.



A **self purging pump** eliminates the hassle of having to manually bleeding air from pumps and lines.



**Dual 24" Fusion Waterfalls:** At one time waterfalls were just to add soothing sounds and a relaxing ambiance to your Spa.



**Digital Float and Fill Gauge:** The illuminated fill gauge for all Cascade Series Spas takes the guesswork out of filling the overflow tank.



Your Spa has the ability to be equipped with the **Worldwide Spa Remote** hardware that is required to take advantage of nearly limitless control and monitoring of your Spa.

### SPA COMFORTS

- Ergonomic Seating
- Multi-Level Seating
- Large Foot wells
- Programmable Filtration



Coast Spas developed the **Hydro Cyclonic Filtration System**. Not only is it more efficient and faster than a skim filtration system but it also removes the dirty filter canisters from the bathing area.

Series	Purfikt	2Purfikt	2Purfikt
Model	Infinity	Traditional	Infinity
Seating	7-8	3-4	3-4
Dims (cms)	292 x 234 x 112 (124.5 at back)	212 x 151 x 101.5	212 x 181.5 x 101.5
Dims (in)	115 x 92 x 44 (49 at back)	83.5 x 59.5 x 40	83.5 x 71.5 x 40
Capacity (l)	1995	880	1155
Capacity (US gal)	527	232	305
Dry Wt (kg)	592	340	386
Dry Wt (lbs)	1305	750	850
Wet Wt (kg)	2610	1220	1541
Wet Wt (lbs)	5754	2690	3340

**DISCLAIMER:** The pictures displayed above are for reference purpose only. Some parts may be different depending upon the spa model.

**DISCLAIMER:** At the time of print, this manual is accurate in its information. Coast Spas reserves all the rights to change/modify any spa designs and/or features without notification. To check on updates or for other information, please visit [www.coastspas.com](http://www.coastspas.com)



# START UP GUIDE

## PURFIKT | 2 PURFIKT INFINITY

### PREP FOR FILLING

**! PLEASE READ ALL INSTRUCTIONS BELOW BEFORE FILLING THE SPA**



Using a cloth and water, wipe away any dirt/dust collected from transport. Ensure all jets are open by turning the face counter clockwise.

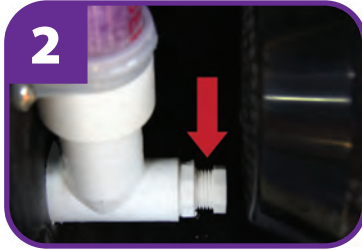

If your spa has a Crystal Clear tube the threaded plug needs to be on prior to filling the spa.



Remove the filter lock ring and lid. Remove filter and take it out of the plastic transport bag.



Put the filter back inside and secure the lid firmly with the locking ring. Loosen air-bleed screw.

### FILLING YOUR SPA

**! DO NOT USE HOT WATER TO FILL YOUR SPA**

**! DO NOT USE WATER FROM A WATER SOFTENER**



Place fill hose inside the spa and fill main body of spa with water until it reaches the infinity edge. Allow water to spill over infinity edge for approximately 60 seconds.



Tighten air-bleed screw.



Turn power to the spa on from GFCI breaker to activate water level gauge. Continue filling until the water gauge reads just below 1/2 full.



Turn power to the spa off from the GFCI breaker for 30 seconds and then turn back on.

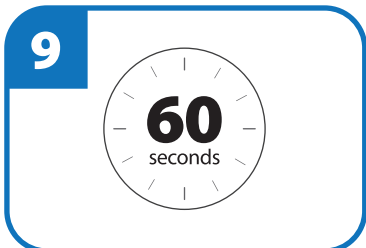

Do not press the back and/or pump #1 button on the control panel. Activate high speed on pumps 2 & 3 (if 3-pump model) or pump 2 (if 2-pump model) by pressing the pump buttons twice. Let run for 60 seconds.

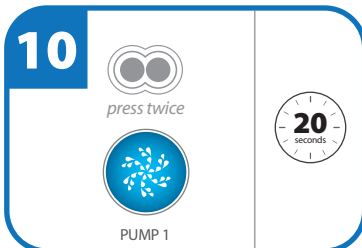

Continue running pumps 2 & 3 (pump 2 on 2-pump models), turn pump 1 on high speed for 20 seconds by pressing the pump 1 icon twice.

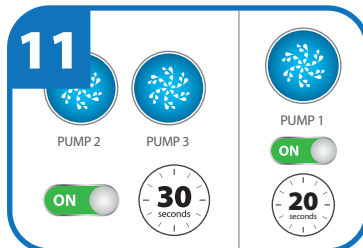

Continue running pumps 2 & 3 (pump 2 on 2-pump models) on high speed for 30 seconds and activate pump 1 on high speed for 20 seconds.



Cascade check valve inside the equipment area, full of water is an indication of no more air in the plumbing line. If the check valve is not full of water, air is still in the plumbing lines.



Release any additional trapped air by loosening the air bleed screw. Wait for all air to be released. Retighten.

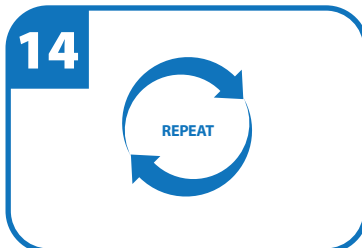

Repeat steps 11-12 until all air has been removed from the system. If air is still in the system it will precede water coming out of the jets when pump 1 is activated.

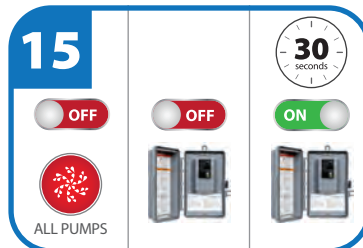

Turn off all pumps. Then turn main power off to the spa for 30 seconds. Then turn power back on.

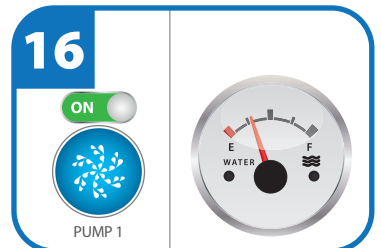

Your water level should read just above 1/4 full on the gauge when pump 1 (high speed) is activated. **Your hot tub is now filled. Set the temperature and get ready to enjoy!**

**IMPORTANT:** Your Infinity Edge Spa will have an additional drain valve that will drain water from the reserve tank. This is separate from the main spa drain system.

## SPA CARE GUIDE

Your authorized dealer carries a wide variety of care and maintenance products. For more information please contact your Dealer.

### REQUIRED FILTER MAINTENANCE

Your new spa is equipped with a filter cartridge. To ensure maximum water quality at all times, you should replace the filter cartridge every six months, or earlier as necessary. The filter cartridge is designed to be thrown away! Attempts to re-use the filter cartridge may result in the re-release of unwanted particles back into the spa.

### PLEATCO DUAL CORE FILTERS

Your spa comes with a premium filter. Most come with equipped with a Pleatco DualCore Filter, which does a better job of cleaning your spa water than any other filter cartridge. The DualCore filter has two layers of filtration media, the outer layer and the inner layer. Both are engineered to remove different particles from your water.

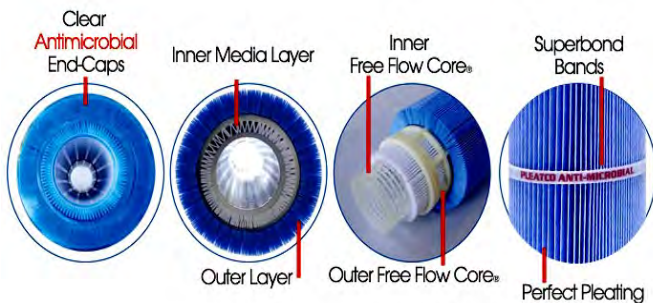

The outer core is similar to a traditional filter which traps larger debris, while the inner core filters the water for particles down to 3 microns in size. The inner core is easily removed and both filter media can be cleaned.

Keeping your spa water clean and refreshing is extremely important for your enjoyment of your spa. Our spas come with only the best filters available in order to ensure your satisfaction.

### REQUIRED WATER REPLACEMENT

You should replace the spas water every 3-6 months. The frequency will depend on a number of variables including frequency of use, number of bathers and attention paid to the water quality maintenance. You will know it is time for a change when you can no longer get the normal feel or sparkle to the water, even though the key water balance measurements are all within the recommended ranges.

- Proper water chemistry must be maintained. Your spa pillows are easily and quickly damaged when exposed to unbalanced spa water. If you suspect that your chemicals may be unbalanced, remove your pillows immediately until the water has been restored to suggested conditions.
- Do not sit on the pillows
- Do not pull on the pillows.
- Pillows should be cleaned using a soft cloth and mild soap, then wiped with a conditioner. We recommend that pillows be washed each time you drain you spa.

This Limited Warranty is void if failure is caused by accident, acts of nature, acts of God, or other causes beyond the control of CSMI. Neglect, misuse and abuse include any installation, operation, or maintenance of the spa other than in accordance with the instructions contained in the owner's manual provided with the spa, including, but not limited to damage caused by operation outside the range of 34 degrees Fahrenheit and 116 degrees Fahrenheit or 1 degree Celsius and 47 degrees Celsius .

Please be advised that the Spa Warranty will become void if Coast Spas or any of its selling or servicing agents determines that the spa has been exposed to Hydrogen Peroxide, TriChlor or any substance using it as an ingredient proven to be dangerous to the Spa. Any condition arising from the use of Hydrogen Peroxide or TriChlor on the Spa is an unwarrantable defect.

### SPA INTERIOR

Your spa has a fiberglass reinforced acrylic shell. Generally dirt and stains will not adhere to the surface. To properly clean the surface, we recommend wiping it with a soft damp cloth (or sponge) using a low sudsing household soap or liquid detergent and rinsing thoroughly with fresh water. Stubborn dirt or stains may be removed by using Spic & Span adequately dissolved in water. Contact your dealer and inquire about maintenance packages.

**DO NOT** use any cleaning products containing abrasives or solvents, since these could damage the surface. Harsh chemicals should never be used on acrylic surfaces. Damage to the shell due to the use of harsh chemicals is not covered under the warranty.

**DO NOT** leave your spa drained and in direct sunlight for extended periods of time. Extreme heat could cause damage

to the acrylic surface and may induce an effect known as "crazing". Crazing is not covered under spa limited warranty.

### STAINLESS STEEL CONTROLS AND COMPONENTS ABOVE THE WATERLINE

To preserve the stainless steel finish of the controls and components above the water line, we recommend they be wiped with a dry soft cloth after each use of your spa. In addition, off-gas your spa by removing the cover for approximately 30 minutes multiple times per week (if not in use) and after every shock treatment.

### CABINET CARE

Never spray cabinets with a high-pressure garden hose or pressure washer for any reason. This action may induce an electrical short in the spa's electrical equipment.

### VINYL CABINET

Vinyl cabinets are made of a rigid polymer that combines the durability of plastic with the beauty of real wood. This cabinet is manufactured so that it won't crack, peel, blister or delaminate even after prolonged exposure to the elements. We recommend wiping the cabinet with a soft damp cloth (or sponge) using household soap or liquid detergent and rinsing with fresh water thoroughly. DO NOT use abrasive cleansers or material as this may damage the surface.

### Purfikt spa door opening instructions

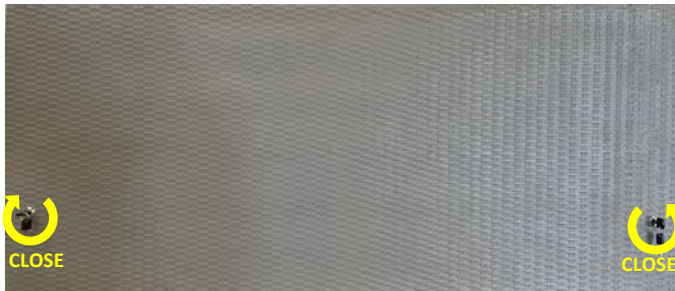

### COVER CARE

A well cared for spa cover is a thing of beauty in its own right. Be sure to clean and condition your cover at least once a month (more often if needed).

### WEATHERSHIELD COVER MAINTAINANCE PROCEDURE

Weather-shield is a solution dyed polyester fabric designed to be flexible and easy for manufacturers to use. Its urethane coating enhances the stability of the weave and allows for greater water resistance, while also minimizing shrinkage and stretching.

Weather-shield features a high UV, water and mold and mildew resistance and has excellent tear and abrasion resistance.

### CARE & CLEANING

Weather Shield is designed to be easy to maintain. It can be washed, or brushed off and rinsed. Proper care and cleaning is important to the life of all fabrics.

### FOR NORMAL CARE AND CLEANING

- Add 2 ounces of mild soap such as Woolite or Dawn dish-washing liquid to 1 gallon of lukewarm water.
- Clean the fabric with a "soft bristle brush."
- Rinse thoroughly with cold water and air dry.

### FOR STUBBORN STAINS

- Add maximum 1 cup of bleach to one 1 gallon of water.
- Spray on lightly to the fabric face (non-coated side). Do not soak fabric.
- Prolonged exposure to harsh chemicals can damage the coating.
- Rinse immediately. Do not leave on for more than 2 minutes.

Cleaning with harsh cleaners such as bleach will require a re-treatment like 303 High Tech Fabric Guard for restoring water repellency.

All waterfalls and laminar flow water features should be turned off when the spa is not in use to avoid heat and water loss.

## BASIC INSTALLATION AND CONFIGURATION GUIDELINES

**WARNING! Qualified Technicians Required for Service and Installation**

### ELECTRICAL REQUIREMENTS

All self contained spas use 120VAC or 240VAC electrical spa packs. These instructions describe the only acceptable electrical wiring procedures. Spas wired in any other way will void your warranty and may result in serious injury. All installations should be completed by a certified electrician. Failure to comply with state and local codes may result in fire or personal injury and will be the sole responsibility of the spa owner.

**120VA:** This requires an isolated 15 Amp circuit breaker. This needs to be an isolated circuit with no other appliances or lights on this circuit at any time. Extension cords are not to be used in conjunction with the operations of the spa. Low voltage damage could result and this is not covered by warranty.

**NOTE:** All components must be 120V; No 240V components allowable.

**240VA:** Depending on the model of spa, it will require either a 40 Amp, 50 Amp, or 60 Amp dedicated circuit breaker, GFCI, with the proper wire size based on the length of the run. The electrical circuit must be installed by a certified electrician and approved by a local building or electrical inspector.

Use minimum 6AWG copper conductors only. Torque field connections between 21 and 23 lbs. Readily accessible disconnecting means to be provided at time of installation. Permanently connected power supply.

Connect only to a circuit protected by a Class A Ground Fault Circuit Interrupter (GFCI) or Residual Current Device (RCD) mounted at least 5' (1.52M) from the inside walls of the spa and in line of sight from the equipment compartment.

#### CSA ENCLOSURE: TYPE 2

Refer to Wiring Diagram inside the cover of the control enclosure. Refer to Installation and Safety Instructions provided by the spa manufacturer.

#### **WARNING! GFCI or RCD Protection.**

The Owner should test and reset the GFCI or RCD on a regular basis to verify its function.

#### **WARNING! Shock Hazard! No User Serviceable Parts.**

Do not attempt service of this control system. Contact your dealer or service organization for assistance. Follow all owner's manual power connection instructions. Installation must be performed by a licensed electrician and all grounding connections must be properly installed. Disconnect the electric power before servicing. Keep access door closed.

#### CSA COMPLIANCE

##### CAUTION:

- Test the ground fault circuit interrupter before each use of the spa.
- Read the instruction manual.
- Adequate drainage must be provided if the equipment is to be installed in a pit.

FOR USE ONLY WITHIN AN ENCLOSURE RATED CSA ENCLOSURE 3. CONNECT ONLY TO A CIRCUIT PROTECTED BY A CLASS A GROUND FAULT CIRCUIT INTERRUPTER OR RESIDUAL CURRENT DEVICE. TO ENSURE CONTINUED PROTECTION AGAINST SHOCK HAZARD, USE ONLY IDENTICAL REPLACEMENT PARTS WHEN SERVICING. INSTALL A SUITABLY RATED SUCTION GUARD TO MATCH THE MAXIMUM FLOW RATE MARKED.

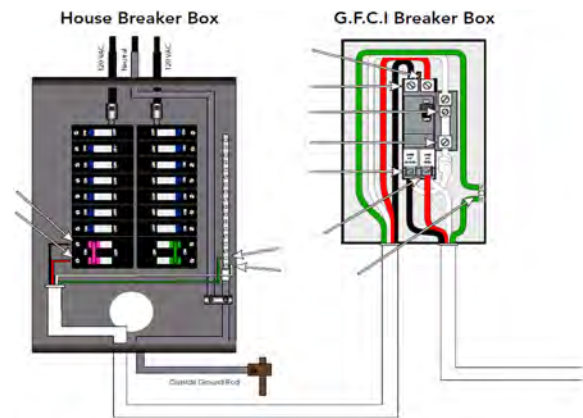

##### WARNING

- Water temperature in excess of 38°C may be injurious to your health.
- Disconnect the electrical power before servicing.

##### CAUTION:

When using this electrical equipment, basic safety precautions should always be followed.

## SPA MAINTENANCE PROCEDURES

### FILTER MAINTENANCE

The spa filter is one of the most important maintenance items of a spa. The filter is there to remove debris from the water and needs to be cleaned on a regular basis. Failure to do so may result in poor performance, poor water clarity and could prevent the spa from heating. Filtration starts as soon as flow is steady through the filter. As the filter cartridge removes the debris from the spa water, the accumulated debris causes flow resistance.

### CLEANING AND REPLACING FILTER CARTRIDGE

Your Purfikt spa filter has been designed for quick and easy maintenance. The filter cartridge should be rinsed by hose once a week and cleaned with a cartridge cleaner once a month. A second filter cartridge is recommended and will speed up this process. This can be purchased from your local dealer.



### TOP LOAD FILTERS

- Turn power OFF at the breaker.
- Loosen air relief valve, then remove retainer ring.
- Pull filter lid straight up to remove.
- Do not twist or pull the filter lid up on an angle. This could cause damage to the filter canister, especially in freezing conditions.
- Remove filter cartridge and clean with a garden hose and a high-pressure nozzle. Periodically you may need to soak your filter in a "cartridge filter cleaner" to remove excess minerals and/or oils.

- Rinse filter thoroughly before installing. Clean O-ring on filter lid and apply a light film of silicone lubricant to the O-ring. Do not use a petroleum-based lubricant as it could damage the O-ring. Consult your authorized dealer to purchase suitable lubricant.
- Place clean Cartridge in filter canister.
- Replace filter lid and re-tighten retaining ring (finger tight only).
  - Note:** Make sure the O-ring is on the air relief valve, and is finger tight prior to starting the pump. This O-ring should periodically be lubricated with a silicone lubricant.
- There is a 3/8" clear line coming from the filter area and this goes to the bottom corner of the spa. This drains all the water from around the filter canister.
- This is a good time to check the skimmer basket. Bring skimmer door (weir) forward and unscrew basket. Clean out debris and reinstall.

### WATER QUALITY MAINTENANCE

Maintaining the quality of the water within the specified limits will serve to enhance your enjoyment and prolong the life of the spa's equipment. It is a fairly simple task, but it requires regular attention because the water chemistry involved is a balance of several factors. There is no simple formula, and there is no avoiding it. An indifferent approach to water maintenance will result in poor and potentially harmful conditions for soaking and even damage to your spa investment. The most important thing to keep in mind is that preventing poor water chemistry is much easier than correcting poor water chemistry. For specific guidance on maintaining water quality, consult your authorized dealer who can recommend appropriate chemical products for sanitizing and maintaining your spa.

### MAINTAIN HEALTHY SPA WATER

**Important!** When maintaining your Purfikt spa's water chemistry, ensure that your cover is removed during any aggressive treatments to allow for dissipation into the air. Take care to remove the cover slowly and let chemicals deplete if you are uncertain if your water is properly balanced.

Always maintain your Cascade Spa's water chemistry within the following parameters:

**pH:** pH is a measure of relative acidity or alkalinity of water and is measured on a scale of 0 to 14. The midpoint of 7 is said to be neutral, above which is alkaline and below which is acidic. In spa water, it is very important to maintain a slightly alkaline condition of 7.2 to 7.8. Problems become proportionately severe the further outside of this range the water gets. A low pH will be corrosive to metals in the spa equipment. A high pH will cause minerals to deposit on the interior surface (scaling). In addition, the ability of the sanitation agents to keep the spa clean is severely affected as the pH moves beyond the ideal range. That is why almost all spa water test kits contain a measure for pH as well as sanitizer.

**Sanitizer (Chlorine or Bromine):** To destroy bacteria and organic compounds in the spa water by breaking them down into non-harmful levels which get filtered out. A sanitizer must be used regularly, either chlorine or bromine. Sanitizing your spa water is the most important spa maintenance you can do for yourself.

**Total Alkalinity:** This refers to the ability of the spa water to resist changes in pH. Controlling alkalinity can help keep your pH in the appropriate range thereby lessening the need for pH balancing. If the TA is too low the pH level will fluctuate rapidly from high to low. If the TA is too high the pH will tend to be too high and will be very difficult to bring back down.

**Calcium Hardness:** This is a measurement of dissolved calcium in the water. Calcium will help control the corrosive nature of the spa's water.

**WARNING:** Never store chemicals inside the equipment area of your spa.

**IMPORTANT:** Do not use Hydrogen Peroxide based sanitizers in your spa. When using Chlorine or Bromine tablets you must use a floating dispenser. These chemicals can have an extremely corrosive effect on certain materials in the spa. Damage caused by use of these chemicals, or improper use of any chemicals, is not covered under the spa's warranty.

**OTHER ADDITIVES:** Many other additives are available for your spa. Some are necessary to compensate for out-of-balance water, some aid in cosmetic water treatment and others simply alter the feel or smell of the water. Your Authorized Dealer can advise you on the use of these additives.



Look for these specialized cleaning attachments at your local dealership.

**IMPORTANT:** The spa or swim spa water shall be tested and treated in accordance with applicable local codes. For Pool and Hot Tub Water Sanitation, see [Uniform Swimming Pool, Spa and Hot Tub Code, Chapter 5 – Water Quality](#).



CHEMICALS (USA)

Coast Spas chemicals play a vital role in ensuring the longevity, cleanliness, and overall enjoyment of your hot tub, swim spa or cold plunge experience.

For optimal performance and to ensure the longevity of your Coast Spas hot tub, swim spa & cold plunge, we strongly recommend using Coast Spas chemicals. Our specially formulated chemicals have been crafted with the utmost precision and care, utilizing premium-grade ingredients and formulations designed to complement the unique engineering of your Coast Spas hot tub, swim spas & cold plunge.

The use of alternative chemical products may lead to unintended chemical reactions, water imbalance, and possible damage to your spa's components. It is important to note that failure to use Coast Spas chemicals may impact your warranty coverage. To safeguard your investment and enjoy uninterrupted relaxation, trust in the quality and compatibility of Coast Spas chemicals — the ideal choice for your Coast Spas hot tub, swim spas & cold plunge.

SCAN THIS QR  
TO DOWNLOAD  
BROCHURE



SCAN ME



# Coast Spas®

## HIGH QUALITY FORMULATION

Coast Spas chemicals are designed to be easy to use and require minimal effort to maintain. This means that customers can spend less time worrying about maintaining their hot tubs, swim spas & cold plunge and more time enjoying them.

## EASY TO USE

Coast Spas chemicals are safe and effective, providing superior user experience for customers. They are designed to work seamlessly with Coast Spas hot tubs, swim spas & cold plunge, ensuring that customers can enjoy their hot tubs, swim spa & cold plunge without any issues.

## RELIABLE AND EFFICIENT

Coast Spas chemicals are safe and effective, providing a superior user experience for customers. They are designed to work seamlessly with Coast Spas hot tubs, swim spa & cold plunge, ensuring that customers can enjoy their hot tubs, swim spa & cold plunge without any issues.



## CHEMICALS (CANADA)

Coast Spas chemicals play a vital role in ensuring the longevity, cleanliness, and overall enjoyment of your hot tub, swim spa & cold plunge experience.

For optimal performance and to ensure the longevity of your Coast Spas hot tub, swim spa & cold plunge, we strongly recommend using Coast Spas chemicals. Our specially formulated chemicals have been crafted with the utmost precision and care, utilizing premium-grade ingredients and formulations designed to complement the unique engineering of your Coast Spas products.

The use of alternative chemical products may lead to unintended chemical reactions, water imbalance, and possible damage to your spa's components. Moreover, it is important to note that failure to use Coast Spas chemicals may impact your warranty coverage. To safeguard your investment and enjoy uninterrupted relaxation, trust in the quality and compatibility of Coast Spas chemicals – the ideal choice for your Coast Spas hot tub, swim spa & cold plunge.

**SCAN THIS QR TO  
DOWNLOAD  
BROCHURE**



## HIGH QUALITY FORMULATION

Coast Spas hot tub, swim spa & cold plunge chemicals are designed by a team of experienced chemists who understand the unique needs of hot tubs, swim spa & cold plunge. They are formulated to provide optimal performance and reliability in Coast Spas hot tubs, swim spas & cold plunge ensuring that customers can enjoy their hot tubs, swim spas & cold plunge for longer periods of time.

## EASY TO USE

Coast Spas chemicals are designed to be easy to use and require minimal effort to maintain. This means that customers can spend less time worrying about maintaining their hot tubs, swim spa & cold plunge and more time enjoying them.

## RELIABLE AND EFFICIENT

Coast Spas chemicals are safe and effective, providing a superior user experience for customers. They are designed to work seamlessly with Coast Spas hot tubs, swim spa & cold plunge, ensuring that customers can enjoy their hot tubs, swim spa & cold plunge without any issues.

## WATER CLARITY TROUBLESHOOTING

PROBLEM	PROBABLE CAUSE	POTENTIAL SOLUTIONS
<b>Water Odor</b>	<ul style="list-style-type: none"> <li>• Improper sanitization</li> <li>• Excessive organics in water</li> <li>• pH is too low</li> </ul>	<ul style="list-style-type: none"> <li>&gt; Add sanitizer</li> <li>&gt; Shock spa with sanitizer</li> <li>&gt; Adjust pH</li> </ul>
<b>Chlorine Odor</b>	<ul style="list-style-type: none"> <li>• Chloramines are too high</li> <li>• pH is too low</li> </ul>	<ul style="list-style-type: none"> <li>&gt; Shock spa with sanitizer</li> <li>&gt; Adjust pH</li> </ul>
<b>Musty Odor</b>	<ul style="list-style-type: none"> <li>• Bacteria or Algae growth</li> </ul>	<ul style="list-style-type: none"> <li>&gt; Shock spa with sanitizer</li> <li>&gt; Drain and refill spa water</li> </ul>
<b>Scale</b>	<ul style="list-style-type: none"> <li>• Total alkalinity is too high</li> <li>• pH is too high</li> <li>• High calcium content in water</li> </ul>	<ul style="list-style-type: none"> <li>&gt; Adjust total alkalinity</li> <li>&gt; Adjust pH</li> <li>&gt; Use stain and scale product</li> </ul>
<b>Stain</b>	<ul style="list-style-type: none"> <li>• Total alkalinity is too low</li> <li>• pH is too low</li> <li>• High metal content in water</li> </ul>	<ul style="list-style-type: none"> <li>&gt; Adjust alkalinity</li> <li>&gt; Adjust pH</li> <li>&gt; Use stain and scale product</li> </ul>
<b>Cloudy Water</b>	<ul style="list-style-type: none"> <li>• Poor filtration</li> <li>• pH is too high</li> <li>• Hardness is too high</li> <li>• Total alkalinity is too high</li> <li>• Suspended particles</li> </ul>	<ul style="list-style-type: none"> <li>&gt; Clean filter cartridge</li> <li>&gt; Adjust pH</li> <li>&gt; Adjust hardness</li> <li>&gt; Adjust total alkalinity</li> <li>&gt; Drain and refill spa water</li> </ul>
<b>Algae Growth</b>	<ul style="list-style-type: none"> <li>• pH is too high</li> <li>• Sanitizer is too low</li> </ul>	<ul style="list-style-type: none"> <li>&gt; Adjust pH</li> <li>&gt; Shock spa with sanitizer</li> <li>&gt; Adjust sanitizer level</li> </ul>
<b>Eye Irritation</b>	<ul style="list-style-type: none"> <li>• pH is too low</li> <li>• Sanitizer is too low</li> </ul>	<ul style="list-style-type: none"> <li>&gt; Adjust pH</li> <li>&gt; Shock spa with sanitizer</li> <li>&gt; Adjust sanitizer level</li> </ul>
<b>Skin Rash/Irritation</b>	<ul style="list-style-type: none"> <li>• Free chlorine level too high</li> <li>• Unsanitary water</li> </ul>	<ul style="list-style-type: none"> <li>&gt; Adjust chlorine level</li> <li>&gt; Shock spa with sanitizer</li> <li>&gt; Adjust sanitizer level</li> </ul>

## TROUBLESHOOTING GUIDE

## SPA SYSTEM

SYMPTOM	PROBABLE CAUSE	RECOMMENDED ACTION
Spa does not work	<ul style="list-style-type: none"> <li>Power is turned off</li> </ul>	<ul style="list-style-type: none"> <li>&gt; Reset GFCI</li> </ul>
No display on the control panel	<ul style="list-style-type: none"> <li>Power is turned off</li> <li>Defective topside control</li> </ul>	<ul style="list-style-type: none"> <li>&gt; Reset GFCI</li> <li>&gt; Contact your Dealer</li> </ul>
Letters on the control panel	<ul style="list-style-type: none"> <li>An error has been found</li> </ul>	<ul style="list-style-type: none"> <li>&gt; Refer to the Reference Card for your control panel to verify the error. Contact your Dealer for service</li> </ul>

## PUMP PROBLEMS

SYMPTOM	PROBABLE CAUSE	RECOMMENDED ACTION
Noisy/Loud motor	<ul style="list-style-type: none"> <li>Air trapped in the pump</li> <li>Low water level</li> <li>Worn pump seal</li> <li>Defective pump</li> </ul>	<ul style="list-style-type: none"> <li>&gt; Open bleed valve in the skimmer</li> <li>&gt; Add water to the spa</li> <li>&gt; Contact your Dealer</li> <li>&gt; Contact your Dealer</li> </ul>
Pumps power down on their own	<ul style="list-style-type: none"> <li>Set temperature has been reached</li> <li>Filtration cycle has ended</li> <li>Automatic time out</li> <li>Overheat safety protection</li> </ul>	<ul style="list-style-type: none"> <li>&gt; No problem</li> <li>&gt; No problem</li> <li>&gt; Pumps are set to run for a predetermined time while the spa is in use (15-20 Mins)</li> <li>&gt; The pumps have a thermal overload which will prevent them from running for extended periods of time. Wait until pumps have cooled down (1+ hrs). If problem persists, contact your Dealer.</li> </ul>
Pump running constantly, will not turn off	<ul style="list-style-type: none"> <li>Filter cycle set to 24 hours</li> <li>Problem with the circuit board</li> </ul>	<ul style="list-style-type: none"> <li>&gt; Turn off 24 hour filtration</li> <li>&gt; Turn power off at GFCI and contact your Dealer</li> </ul>
Pump will not turn on	<ul style="list-style-type: none"> <li>GFCI tripped</li> <li>Motor has overheated</li> <li>Not plugged in</li> <li>Damaged plug</li> <li>Seized motor</li> <li>Blown fuse</li> <li>Motor vent is blocked</li> </ul>	<ul style="list-style-type: none"> <li>&gt; Reset the GFCI</li> <li>&gt; Let cool for 1+ hour</li> <li>&gt; Plug in to the board</li> <li>&gt; Contact your Dealer</li> <li>&gt; Contact your Dealer</li> <li>&gt; Check fuse or contact your Dealer</li> <li>&gt; Clear debris from the vent</li> </ul>

HEAT PROBLEMS	PROBABLE CAUSE	RECOMMENDED ACTION
<b>Water will not heat</b>	<ul style="list-style-type: none"> <li>• Error message on control panel</li> <li>• Spa is in a different Heat Mode</li> <li>• Water level is too low</li> <li>• Poor water flow</li> <li>• Closed valves</li> <li>• Pump 1 is not running</li> </ul>	<ul style="list-style-type: none"> <li>&gt; Refer to the Reference Card for your control panel to verify the error</li> <li>&gt; Set spa to "Standard Mode"</li> <li>&gt; Add water to the spa</li> <li>&gt; Clean filter &amp; check valves</li> <li>&gt; Open all valves</li> <li>&gt; Contact your dealer</li> </ul>
<b>Water is too hot</b>	<ul style="list-style-type: none"> <li>• Incorrect reading</li> <li>• Filter cycle duration is too long</li> </ul>	<ul style="list-style-type: none"> <li>&gt; Verify temperature with thermometer</li> <li>&gt; Reduce duration of the filter cycle</li> </ul>
<b>Water will not maintain heat</b>	<ul style="list-style-type: none"> <li>• Cover is off for extended periods of time in cold weather / cold wind.</li> <li>• Spa is wired for 110V and jets are on.</li> </ul>	<ul style="list-style-type: none"> <li>&gt; Put cover back onto spa and allow for heat to regenerate. Call your dealer if temperature does not increase.</li> <li>&gt; Spa wired for 110V only have enough power to heat or operate pumps. Turn off jets to power heater.</li> </ul>

LIGHTING ISSUES	PROBABLE CAUSE	RECOMMENDED ACTION
<b>Standard light will not come on</b>	<ul style="list-style-type: none"> <li>• Bulb has burnt out</li> </ul>	<ul style="list-style-type: none"> <li>&gt; Replace the light bulb</li> </ul>
<b>LED lighting not in sync</b>	<ul style="list-style-type: none"> <li>• Burnt out bulb/connection</li> </ul>	<ul style="list-style-type: none"> <li>&gt; Contact your dealer</li> </ul>
<b>LED lighting won't come on</b>	<ul style="list-style-type: none"> <li>• Incorrect settings</li> </ul>	<ul style="list-style-type: none"> <li>&gt; Contact your dealer</li> </ul>

PUMPS WILL NOT PRIME	PROBABLE CAUSE	RECOMMENDED ACTION
<b>Pump on but no water flow</b>	<ul style="list-style-type: none"> <li>• Air trapped in pump</li> <li>• No water in the pump</li> <li>• Closed valves</li> </ul>	<ul style="list-style-type: none"> <li>&gt; Loosen bleed valve in skimmer</li> <li>&gt; Check the fill level in the spa</li> <li>&gt; Open all valves</li> </ul>

HYDROTHERAPY JETS	PROBABLE CAUSE	RECOMMENDED ACTION
<b>Little to no water flowing from jets</b>	<ul style="list-style-type: none"> <li>• Jets turned off</li> <li>• Pump not primed</li> <li>• Valves are closed</li> <li>• Diverter set to a different seat</li> <li>• Dirty filter</li> </ul>	<ul style="list-style-type: none"> <li>&gt; Open jet by turning the face counter clockwise</li> <li>&gt; Reset breaker to allow for the spa to prime the pump. Open bleed valve in the skimmer area</li> <li>&gt; Open valves</li> <li>&gt; Switch diverter</li> <li>&gt; Remove and clean filter cartridge</li> </ul>

PLUMBING SYSTEM	PROBABLE CAUSE	RECOMMENDED ACTION
<b>Water around base of spa</b>	<ul style="list-style-type: none"> <li>• Loose connections</li> <li>• Leak from internal fitting</li> </ul>	<ul style="list-style-type: none"> <li>&gt; Hand tighten all quick disconnects and fittings.</li> <li>&gt; Check gaskets and O-rings</li> <li>&gt; Contact your dealer</li> </ul>

## DRAINING AND WINTERIZING

### DRAINING YOUR SPA

After a period of 3-4 months, detergent residues from bathing suits and soap film will build up in your spa water. Once this happens, your spa water will appear cloudy and should probably be replaced.

- Turn power OFF at the breaker.
- Locate the drain valve (usually in the equipment area).
- Remove the safety cap and attach garden hose.
- Drain water to a convenient area (Spa water may harm grass or plants if sanitizer levels are high.)
- When water begins to flow out of the hose, open the air relief valve located on filter lid (Hydro-Cyclonic Filtration) or Air Bleeder Valve (Skim Filtration).
- Your spa will drain except for a small portion left in the foot well. This can be removed with a sponge and pail.
- Once empty, clean as required.
- To finish, remove garden hose and attach safety cap.



### WINTERIZING YOUR SPA

In many areas of the world the temperature may drop below 32° F (0°C). We recommend the spa is always filled with water and running at normal spa temperatures. By doing this you will minimize the risk of freezing within your spa. If it is necessary to leave your spa unattended for long periods of time during cold weather conditions, you should drain your spa to avoid accidental freezing caused by power outages.

Your local dealer can perform the following winterizing procedures, if you are not completely comfortable with them.

- Ensure that you have fully drained the spa (Refer to the DRAINING YOUR SPA section).
- After draining, your spa may still have water remaining in the equipment and plumbing fittings. Disconnect the hand-tightened union fittings going to and from the jet pumps. Be careful not to lose the O-rings between the unions and pump housing.

- Leave drain valve in the open position and safety cap off .
- To completely drain the plumbing lines, a wet/dry shop vacuum can be used to draw out any remaining water. Place the vacuum hose over the jet fittings in the spa as well as the plumbing lines in the equipment area. You should also disconnect the plug on the crystal clear inspection tube (if installed).
- Remove the filter cartridge and store in a warm, dry area.
- Clean the spa shell and place spa cover on spa. Be sure to lock the cover in place in case of high winds or rain.

**WARNING:** The instructions above should be followed accordingly when winterizing your spa however they are guidelines and potential freeze damage may still occur. All freeze damage is the sole responsibility of the spa owner and will not be covered by the warranty should it occur.

**EMERGENCY SITUATIONS:** To eliminate freezing in the event of equipment failure, use a 100-watt light bulb or small heater via extension cord and place it in the equipment area, keeping it away from plumbing lines. This will help for a short period of time until proper service can be rendered.



## DRAINING INSTRUCTIONS

1. On the control panel (settings) select **hold**. This will suspend all functions so that the spa can start to be drained.
2. Remove the false bottom in cabinet area.
3. Connect your hose to the hose bib located in the lower compartment. Open the hose bib valve until water starts coming out of the drain hose.
4. Turn evacuation pump power switch ON - located at the top left of the enclosure.
5. The length of time it will take to drain depends on the size of your spa. On average it will take approximately 1 hour.

**If you have an Infinity Edge Spa** allow it to drain for 30 minutes and then take it off of **hold**. Pump 1 will run on low speed to drain the tank into the main body of the spa.

Let pump 1 run on low speed until the water stops coming out of the jets/waterfall and immediately put the system back into **hold** (refer to step one).

6. Allow spa to finish draining. When fully drained, switch off the evacuation pump and close the hose bib valve.
7. Switch off power to the spa via the main GFCI Breaker.
8. You may have to use a shop vacuum to remove any excess water. Clean the spa before refilling. Refer to your Owner's Manual for proper filling instructions. Once the spa is filled, **prior to adding chemicals**, open the hose bib valve for approx. 15 seconds to allow fresh water to flush the Water-Vac™ System then close the hose bib valve.

## IMPORTANT PLEASE READ

Do not leave your spa unattended while draining. After 90 minutes the hold function is disabled and will allow your spa pumps to activate. This could cause damage to your equipment.

PURFIKT SPA CONTROL PANEL



Please click on the link below or scan the QR code to download the Control Panel user guide.

<https://coastspas.com/downloads/Purfikt%20Collection%20Control%20Panel%20Manual.pdf>



**CONTROLMYSPA™**

**CMS™ SYSTEM CONSISTS OF:**



WEBSITE

ControlMySpa™ website with Login and access to spas

**CMS™ GATEWAY ULTRA Modules**



Home Module



Spa Module

[www.balboawater.com/GatewayUltra](http://www.balboawater.com/GatewayUltra)

**SMARTPHONE | TABLET**



iOS (Apple) ControlMySpa™ mobile app and/or Android ControlMySpa™ Mobile app

The ControlMySpa™ system consists of:

- ControlMySpa™ GATEWAY ULTRA installed on a spa/Hot Tub
- iOS (Apple) ControlMySpa™ mobile app or Android ControlMySpa™ mobile app
- ControlMySpa™ website with log-in and access to spas

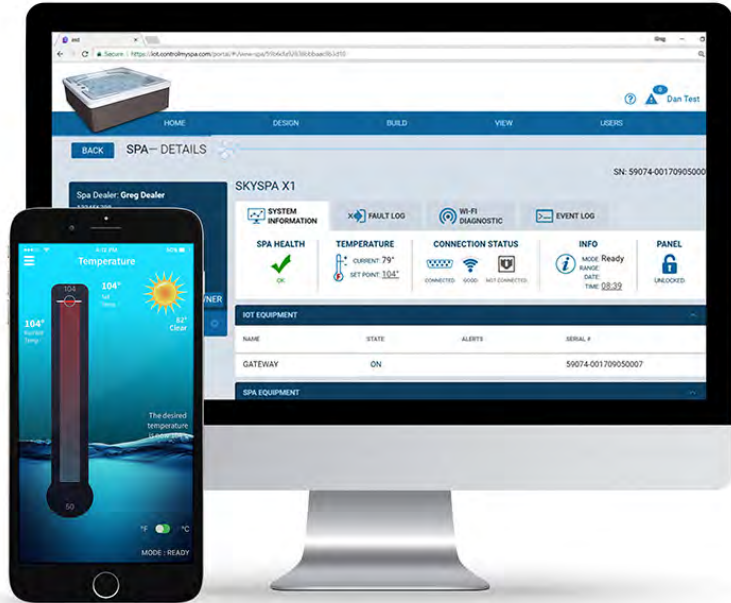

The ControlMySpa™ Logins:

- The iOS or Android ControlMySpa™ apps can only be accessed with an owner log-in
- The ControlMySpa™ website can be accessed with an owner log-in.

**ControlMySpa™ App for the smart device**

**FOR IPHONE® OR IPAD® (IOS/APPLE)**

Search the Apple iOS App Store for “controlmyspa” Or

Use this link: <https://goo.gl/j31t1V>



**FOR ANDROID® PHONES/TABLETS**

Search Google Play App Store for “controlmyspa”

Or Use this link: <https://goo.gl/CG4Yci>



ControlMySpa™

Connect GATEWAY ULTRA hardware in your home

Step 1

Plug the supplied ethernet cable into the home router (A).

Step 2

Plug the other end of the ethernet cable into the GATEWAY ULTRA module (B).

Step 3

Plug the supplied power cord into the GATEWAY ULTRA module (C).

Step 4

Plug the other end of the supplied power cord into wall power (D).



GATEWAY ULTRA Module (side view)

LED Light Chart (E)

This chart applies to the home and spa GATEWAY ULTRA modules.

- Red - Solid: The GATEWAY ULTRA and the spa are not connected.
- Red - Blinking: Home and spa GATEWAY ULTRA modules are connected, but no connection to the spa controller.
- Blue - Blinking: Remote software update is underway. Do not unplug power.
- Green - Blinking: CMS™ GATEWAY ULTRA spa and home modules RF is connected, but no connection to internet.
- Green - Solid: Spa successfully connected to internet. No errors.

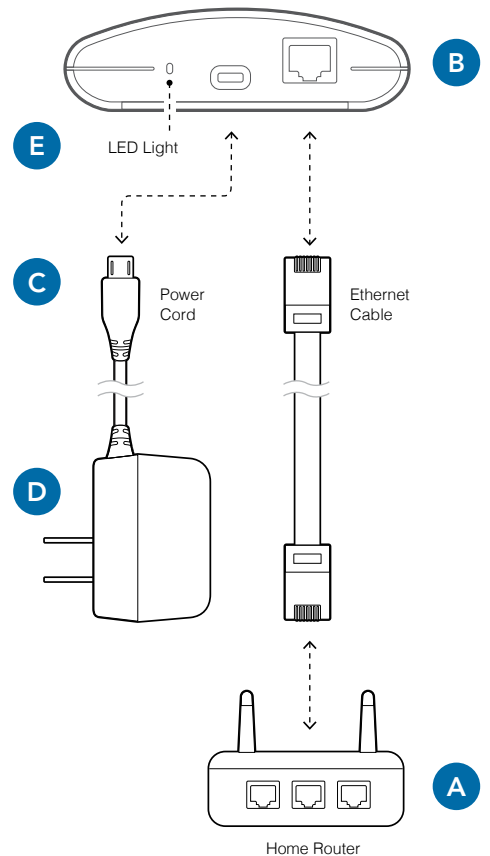

## CMS™ Code Overview

### WHAT IS A CMS™ CODE?

- CMS™ Code is an 8 digit letter/number combination that all Spa owners must have to use spas equipped with the ControlMySpa™ system
  - A) The CMS™ code is obtained from your Dealer.
- Spa owners will need this CMS™ code to setup and connect their spas in the ControlMySpa™ database.
- The CMS™ code connects your spa to your OEM and Dealer for service and support

### EXAMPLE CMS™ Code: ABC-12345

ABC = 3 letter code unique to each spa Manufacturer or OEM 12345 = 5 number code unique to each spa Dealer or Distributor

## ControlMySpa™

### Setup Spa Owner User Account

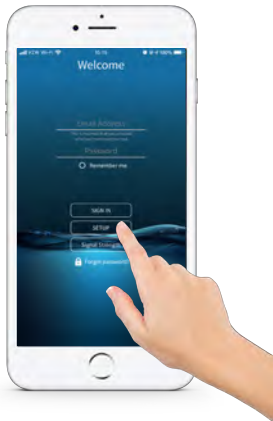

- 1. Open the app on your smart device**  
Press "SETUP" on the app.



- 2. Press "Next"**  
Confirm Bluetooth is ON in the iOS Settings.



- 3. Press "Next"**  
Stand near your spa (within 10 feet/3 meters) and ensure the spa power is ON by pressing the topside panel. If the spa is powered ON, press "Next".



- 4. Detect Bluetooth**



**5. Press "Yes"**  
The serial number in the app should match the serial number on the back of the spa module.

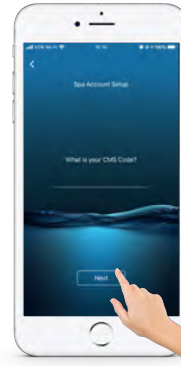

**6. Press "Next"**  
The CMS code is provided by your Dealer. Press "Next".



**7. Press "Next"**  
Input information and press "Next".



**8. Press "Next"**  
Input information and press "Next".

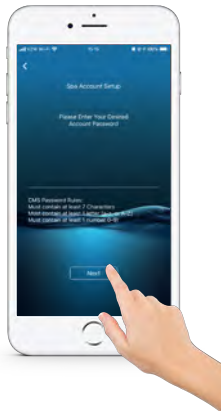

**9. Press "Next"**  
Input information and press "Next".

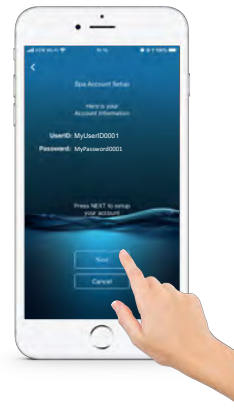

**10. Press "Next"**  
Your UserID and password will appear. Press "Next".

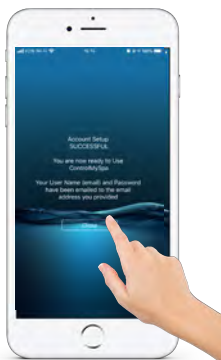

**11. Press "Close"**



**12. Press "SIGN IN"**  
Input your email address, password and press "SIGN IN".

**SUCCESS! YOUR ACCOUNT IS SETUP, AND YOU CAN CONTROL YOUR SPA WITH THE CMS APP.**

## BALBOA WI-FI

This is an optional feature. The Spa can be controlled by using the Balboa Worldwide App (bwa™) that allows you to access your spa via a direct connection anywhere in the local proximity of your tub, anywhere in your house that you can connect to your local Wi-Fi network, or anywhere in the World you have an Internet connection to your smart device via 3G, 4G, or Wi-Fi. The bwa™ app can be downloaded from Google play store or Apple App store. Follow instructions on the app to complete the setup and connect to the Purfikt spa.



**Balboa Wi-Fi Module**



**bwa™ for Android™**

**bwa™ for iOS®**

## BALBOA ULTRAZONE OPERATION

- Ozone will turn on during the programmed filter cycles and pump #1 operation.
- Verify that the green light on the Ozone turns on when activated.
- Check the spa drain (at the bottom of the spa) to verify that small ozone bubbles are coming out.
- Verify that one way check valve is installed on the ozone tubing and it is working as intended.



For more information on app setup follow the link below:

<https://www.balboawatergroup.com/bwa>

## COAST SPAS ECOCLEAN UV STERILIZER



### HOW IT WORKS

- Ultraviolet germicidal UV lamps are low pressure mercury vapor lamps which produce the UV-C dose necessary for microorganism's eradication.
- This dose (mJ/cm<sup>2</sup>) is the result of a design taking care of the flow rate, the water transmittance, reactor size and exposure time.
- Ultraviolet light is generated by an electrical discharge through low pressure inert gases and mercury vapor with the special quartz tube of the lamp.
- UV Rays generated at 254 Nm are germicidal at the optimal wavelength for eradicating micro-organisms
- Eradicates organisms that can actually live in a chlorinated environment.
- Your EcoClean UV Sterilizer imparts nothing into the water, making it an eco-friendly, reliable and effective choice.
- The sterilizers UV Bulb should be replaced and its protective quartz tube cleaned every 18 months.
- The UV-C rays of our sterilizer take care of in-line sanitation however, weekly shocking of the water is advisable to oxidize any chloramines or contaminants. An ozonator is also recommended as an excellent complimentary device for oxidation.

### EASY MAINTENANCE

- Your NEW Coast Spas EcoClean UV Sterilizer is installed out of sight, concealed by your spa skirt. Quick access is gained through simply removing one skirt panel.
- Replacement of the UV lamp: Every 13 000 operating hours
- Clean quartz tube at time of lamp replacement (12 to 18 months)

### QUICK FACTS

- The unique quartz tube of the EcoClean UV Sterilizer blocks out all but UV-C 254 Nm rays. Any less and a sterilizer is less effective for spas. Similarly, if a sterilizer exceeds this intensity, it will break down chlorine or bromine and be less effective as a result.
- Although you should keep your spa water balanced, balancing chemicals do not alter the effectiveness of the sterilizer, as it neutralizes 99.9% of viruses and bacteria.
- Because the EcoClean UV Sterilizer is eliminating chloramines and organisms in-line, the free chlorine or bromine, of which you still must maintain recommended levels, is more efficient – you can save up to 70% in sanitizing chemical use.

- Remember to keep the recommended free residual of chlorine or bromine in the water as required in your specific region (Canada 3 to 5 ppm of chlorine or bromine).
- Made in the U.S.A (UL/CE/EPA Approved)







**WORLD'S BEST BUILT SPAS**