

— 2022 —

CASCADE II

Coast Spas Manufacturing
6315 202 Street, Langley BC Canada
604 514 8111
info@coastspas.com
www.coastspas.com



Thank you for choosing us!

Here at Coast Spas we have over 20 years of experience crafting the World's Best Built Spas®. Our mission is to deliver the highest quality spas with exceptional performance to help improve your overall wellness. We are so glad you've chosen a Coast Spa and we hope you, your family and friends all enjoy it for years to come.

Sincerely,

A handwritten signature in black ink, appearing to read "Patricia Diamente".

Patricia Diamente, CEO & President



CONGRATULATIONS!

YOU'RE ALMOST READY TO ENJOY YOUR NEW SPA!

Before you begin to enjoy your spa, please take a moment to submit your spa warranty. For registering your spa, you will need the spa serial number. Picture below will help you locate the serial number on your spa.

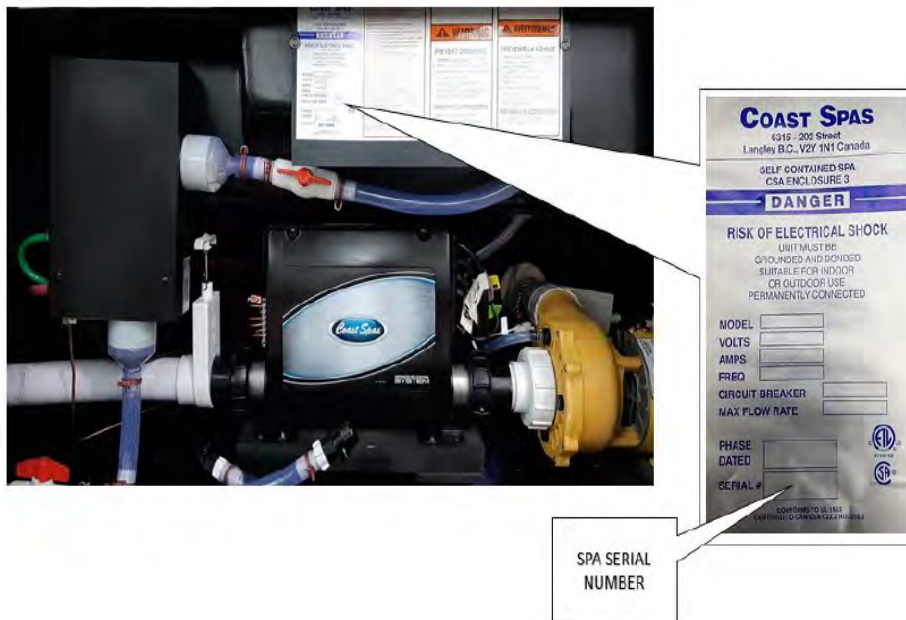

You can register your spa by using below link.
<https://coastspas.microsoftcrmpartals.com/>

FOR YOUR REFERENCE

Spa owner name: _____

Address: _____

Contact: _____ Email: _____

Spa Serial number: _____ Purchase Date: _____

Delivery Date: _____ Dealer Name: _____

Contact your spa selling dealer if you have any queries related to your Cascade Spa. Coast spas authorized dealers are trained professionals who can assist you with spa parts, setup, operations, maintenance, and technical support.

DISCLAIMER: At the time of print, this manual is accurate in its information. Coast Spas reserves all the rights to change/modify any spa designs and/or features without notification. To check on updates or for other information, please visit www.coastspas.com

TABLE OF CONTENTS

Letter from Coast Spas Manufacturing Inc.	<i>Page</i>	2
Registering your spa	<i>Page</i>	3
Table of contents	<i>Page</i>	4
Basic information	<i>Page</i>	5
Important safety instructions and glossary of terms	<i>Page</i>	6-8
Infinity spa general layout	<i>Page</i>	9
Infinity spa features	<i>Page</i>	10
Start up guide— Infinity edge spas	<i>Page</i>	11
Infinity spa care guide	<i>Page</i>	12-14
Basic installation and configuration guidelines : Electrical requirements	<i>Page</i>	14-15
Infinity spa maintenance procedures	<i>Page</i>	15-17
Water clarity troubleshooting	<i>Page</i>	18
Troubleshooting guide	<i>Page</i>	19-20
Draining & winterizing	<i>Page</i>	21
Infinity spa jet operations	<i>Page</i>	22-23
Infinity spa specifications	<i>Page</i>	24
Infinity spa controls	<i>Page</i>	25-36
Balboa Wi-Fi module	<i>Page</i>	37
Control My Spa™	<i>Page</i>	38-41
Balboa Bluetooth Audio	<i>Page</i>	42-44
Coast Status	<i>Page</i>	45-46
Coast Spas EcoClean UV and Sanitizer	<i>Page</i>	47
Infinity spa service log	<i>Page</i>	48-49

IMPORTANT GFCI INFORMATION

Based on the testing conducted by the supplier of the true variable speed pumps, the Siemens brand GFCI can filter electrical spikes and avoid false trips. The use of a 60 Amp Siemens GFCI is recommended with the Atlas Swim System.



PLEASE READ YOUR ENTIRE OWNER'S MANUAL BEFORE SPA OPERATION



Basic Information

Water Care

IMPORTANT: Caring for your water by ensuring proper chemical usage is the single most important thing you can do to keep your Cascade Spa in good condition.

WARNING: Improper chemical usage and maintenance will quickly lead to severe issues with your spa and can effect the spa equipment, jets, pumps, and all other components in contact with the spa water. **All Cascade Spas are susceptible to damage from unbalanced spa water.**

Always maintain your water chemistry within the following parameters.

pH	7.2 - 7.8
Chlorine	1.0 - 3.0 ppm
Bromine	2.0 - 5.0 ppm
Total Alkalinity	100 - 120 ppm
Calcium Hardness	150 - 250 ppm

Electrical

All self contained spas use 120VAC or 240VAC electrical spa packs.

120VAC: requires an isolated 15 Amp circuit breaker, an isolated circuit with no other appliances or lights on the circuit at any time. Extension cords are not to be used in conjunction with the operations of the spa. Low voltage damage could result and this is not covered under warranty.

IMPORTANT: Cascade Spas with 110V means that the jets and heater will not work at the same time.

NOTE: All components must be 120V. No 240V components allowable.

240VAC: Depending on the model of the spa, it will require either a 40, 50, or 60 Amp dedicated circuit breaker with the proper wire size (gauge) based on the length of the run.

The electrical circuit must be installed by a certified electrician and approved by a local building or electrical inspector.

Surface

Your new portable spa must be placed on a firm, flat, and level surface, so that the weight is supported uniformly. We recommend no less than a 3" (93 mm) thick concrete slab. Wood decking or balconies must be constructed to support 150 pounds per square foot (730 kg/m²). Refer to the local and current building codes in your area. Should your new spa need to go through the gate or space – restricted area, ensure you've communicated those limitations with your dealer to avoid delivery complications.

NOTE: Damage caused by alternate decking methods may avoid the spa warranty. Contact your dealer if you have any questions regarding spa location and placement.

Transport

Your new spa has left the factory cleaned and polished and ready to begin operation after passing our many quality and operational tests. However, depending on your location in the world, your spa may have spent days or even weeks in transit before arriving at your home. Please ensure that before filling or operating your Cascade Spa that you check all electrical and plumbing connections are securely connected in the equipment area as they might have loosened during shipping. If any dirt has accumulated, you will want to remove with a clean cloth or sponge using warm water.

IMPORTANT SAFETY INSTRUCTIONS

READ AND FOLLOW ALL INSTRUCTIONS CAREFULLY

DANGER: Risk of Injury. The suction fittings in this Cascade Spa are sized to match the specific water flow created by the pump. Should the need arise to replace the suction fittings or the pump, be sure that the flow rates are compatible. Never operate the Cascade Spa if the suction fittings are broken or missing. Never replace a suction fitting with one rated less than the flow rate marked on the original suction fitting.

DANGER: Risk of Accidental Drowning. Do not allow children to be in or around the spa without adult supervision. Keep the spa cover on and locked when not in use. See instructions enclosed with the cover for locking procedures.

DANGER: Risk of Electrical Shock. The electrical supply for this product must include a suitably rated switch or circuit breaker to open all ungrounded supply conductors to comply with section 422-20 of the National Electrical Code, ANSI/NFPA 70. The disconnect must be readily accessible and visible to the Cascade Spa occupant but installed at least 5 feet (1.5 m) from the Cascade Spa water.

READ, FOLLOW AND SAVE THESE INSTRUCTIONS

- a) A green colored terminal or a terminal marked G, Gr, Ground, Grounding or the symbol * is located inside the supply terminal box or compartment. To reduce the risk of electric shock, this terminal must be connected to the grounding means provided in the electric supply service panel with a continuous copper wire equivalent in size to the circuit conductors that supply this equipment.
- b) At least two lugs marked "Bonding Lugs" are provided on the external surface or on the inside of the supply terminal box compartment. To reduce the risk of electric shock, connect the local common bonding grid in the area of the Cascade Spa to these terminals with an insulated or bare copper conductor not smaller than No. 6 AWG.
- c) All field-installed metal components such as rails, ladders, drains or other similar hardware within 5 feet (1.5 m) of the Cascade Spa shall be bonded to the equipment grounding buss with copper conductors not smaller than No. 6 AWG.

WARNING: To Reduce the Risk of Injury: The water in a Cascade Spa should never exceed 104 °F (40 °C). Water temperatures between 100 °F (38 °C) and 104 °F (40 °C) are considered safe for a healthy adult. Lower water temperatures are recommended for young children and when Cascade Spa use exceeds 10 minutes.

Since excessive water temperatures have a high potential for causing fetal damage during the early months of pregnancy, pregnant or possibly pregnant women should limit Cascade Spa water temperatures to 100 °F (38 °C). If pregnant, please consult your physician before using a Cascade Spa. Before entering the Cascade Spa, the user should measure the water temperature with an accurate thermometer since the tolerance of water temperature regulating devices may vary as much as +/- 5 °F (2 °C). Persons suffering from obesity or a medical history of heart disease, low or high blood pressure, circulatory system problems or diabetes should consult a physician before using a Cascade Spa.

CAUTION: Risk of Hyperthermia: Hyperthermia occurs when the internal temperature of the body reaches a level several degrees above the normal body temperature of 98.6 °F (37 °C). The symptoms of hyperthermia include drowsiness, lethargy, and an increase in the internal temperature of the body. Prolonged immersion in hot water may induce hyperthermia. A description of the causes, symptoms, and effects of hyperthermia are as follows:

- Unawareness of impending hazard;
- Failure to perceive heat;
- Failure to recognize the need to exit Cascade Spa;
- Physical inability to exit Cascade Spa;
- Fetal damage in pregnant women; and
- Unconsciousness and danger of drowning.

WARNING: Children should not use Cascade Spas without adult supervision.

WARNING: Do not use Cascade Spas unless all suction guards are installed to prevent body and hair entrapment.

WARNING: People with infectious diseases should not use a Cascade Spa.

WARNING: To avoid injury, exercise care when entering or exiting the Cascade Spa.

WARNING: Do not use drugs or alcohol before or during the use of a Cascade Spa to avoid unconsciousness and possible drowning. The use of alcohol or drugs can greatly increase the risk of fatal hyperthermia in Cascade Spas.

WARNING: Pregnant or possibly pregnant women should consult a physician before using a Cascade Spa.

WARNING: Water temperature in excess of 38 °C (100 °F) may be injurious to your health. Before entering the Cascade Spa, measure the water temperature with an accurate thermometer.

WARNING: Do not use a Cascade Spa immediately following strenuous exercise.

WARNING: Prolonged immersion in a Cascade Spa may be injurious to your health.

WARNING: Do not permit electric appliances (such as lights, telephone, radio, television, etc.) within 5 feet (1.5m) of this Cascade Spa unless such appliances are built-in by the manufacturer.

WARNING: People using medication and/or having an adverse medical history should consult a physician before using a spa or Cascade Spa.

WARNING: Maintain water chemistry in accordance with the Manufacturers instructions.

WARNING: The equipment and controls shall be located no less than 1.5 meters horizontally from the spa or Cascade Spa.

CAUTION: Observe a reasonable time limit when using the Cascade Spa. Long exposures at higher temperatures can cause high body temperature. Symptoms may include dizziness, nausea, fainting, drowsiness, and reduced awareness. These effects could possibly result in drowning.

CAUTION: Enter and exit the Cascade Spa slowly. Wet surfaces can be very slippery.

CAUTION: Proper chemical maintenance of Cascade Spa water is necessary to maintain safe water and prevent possible damage to Cascade Spa components. Maintain water chemistry in accordance with manufacturer's instructions.

CAUTION: Use the straps and clip tie downs to secure the cover when not in use. This will help to discourage unsupervised children from entering the Cascade Spa and keep the Cascade Spa cover secure in high-wind conditions. There is no representation that the cover, clip tie-downs, or actual locks will prevent access to the Cascade Spa.

CAUTION: For exercise, the water should not exceed 90 °F (32 °C).

GLOSSARY OF TERMS



AIR CONTROL: Mounted generally on the lip of the spa, it induces warm air from the equipment enclosure into the jet stream through venturi action.



WATER DIVERTER: The large diverter is used to divert water to various seats in the spa.



FILTER AIR RELIEF VALVE: Located on top of dome filter lid. Used to release air from the filter.



SKIMMER BLEEDER VALVE: Located in the skimmer area, needs to be loosened while filling the spa. This will help eliminate air from being trapped in the spa equipment.



OZONATOR: The ozonator produces natural ozone through the Corona Discharge process. Continuous use of an ozonator can dramatically reduce sanitizer consumption.



CONTROL BOX (Pack): Basically the "heart" of the spa. Power is distributed to any/all functions of the spa: pumps, ozonator, LED lighting, heater element, etc.



TOPSIDE CONTROL: Mounted on the top lip of the spa and controls the functions of the spa.



EQUIPMENT ENCLOSURE: An enclosure that houses the control box, pump(s) and other electrical components.

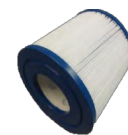

FILTER: The filter cleans the spa by passing water through a filter cartridge where debris and impurities are removed. Top load filter means the filter cartridge is accessible through the top of the spa. Front access skimmer means cartridge is accessed through door of skimmer.



FLOOR DRAIN: The floor drain is covered by a grate-type cover and is utilized when draining the spa. It also acts as the return for the ozonator. You will see bubbles emitted from this drain, which is the result of water mixing with the ozone output.



GATE VALVES: Red with a grey handle is located at the inlet and outlet of the pumping system. Used while servicing the spa equipment, the valves open or close the water flow to the equipment. To remain open for normal use, turn fully counterclockwise.



KNIFE VALVES: A white "T"-handled valve, same functions as Gate valve (see above), except to open them you pull up on handle.



HEATER: The electronically controlled heater raises the temperature of the spa to the desired setting.



LEDs: LEDs and their special lenses can be used to achieve the desired mood lighting in the spa and spa jets.

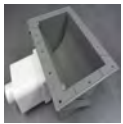

SKIMMER: This is the rectangular outlet at the water level. The skimmer removes surface debris to the filter. The water level in the spa should be kept $\frac{1}{2}$ to $\frac{3}{4}$ up on the skimmer for optimum operation.

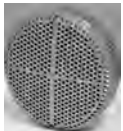

SUCTION: During operation of the equipment, the suction works in conjunction with the skimmer to draw water from the bottom of the spa through the filter, keeping the spa sparkling clean.



NECK JET: Direction-controllable jet for soothing neck massage.



ADJUSTABLE CLUSTER JET: Our adjustable, high-intensity hydrotherapy jet.



DIRECTIONAL JET: Provides a straight flow for a therapeutic massage



ROTATIONAL JET: Provides a Unidirectional circular therapeutic massage.



MASSAGE JET: Delivers massage in staccato bursts over a narrow, focused area.



VOLCANO/WHIRLPOOL JET: high-output jet designed for foot and leg massage.



LAMINAR FLOW: A thin stream of water that arcs from the spa lip.

PREPARATION, SET-UP AND LOCATION FOR YOUR NEW SPA:

- You want to keep in mind how you intend to use the spa and plan the location accordingly.
- How close is the spa from the exit or entrance to your house? (consider the cold weather)
- Is the path to your spa clean of debris, sand, grass? (so as not to track into the spa)
- Is there protection from wind, inclement weather?
- Can neighbors or passersby see the spa?

NOTE: Allow for service access: Many spa owners enjoy placing their spa in a decorative enclosure or a deck. Keep in mind that you need to have access to the equipment for maintenance and the spa should be able to be moved or lifted without destroying the special enclosure or its surroundings. You should discuss this with your dealer when designing the location. Extension cords are not to be used in conjunction with the operations of the spa. Low voltage damage could result and this is not covered by warranty.

NOTE: All components must be 120V; No 240V components allowable.

240VAC: Depending on the model of spa, it will require either a 40 Amp, 50 Amp, or 60 Amp dedicated circuit breaker, GFCI, with the proper wire size based on the length of the run. The electrical circuit must be installed by a certified electrician and approved by a local building or electrical inspector.

DISCLAIMER: The pictures displayed above are for reference purpose only. Some parts may be different depending upon the spa model.

CASCADE II SPA GENERAL LAYOUT (Your spa may look different)



- | | |
|---|----------------------|
| 1. Pillows | 12. Poly Jets |
| 2. Air Control | 13. Suction |
| 3. Extreme XL Water Diverters | 14. Spa Drain |
| 4. Speaker | 15. Cluster Jets |
| 5. Laminar Jets | 16. Coast Connect |
| 6. Control Panel | 17. 3" Spa Light |
| 7. Hydro Cyclonic Water Filtration System | 18. Floor Sweeper |
| 8. Spa LED | 19. Carousel Jet |
| 9. Storm Jets | 20. Skimmer |
| 10. 24" Waterfall | 21. Volcano Jet |
| 11. Water Table Shut Off | 22. Laminar Shut Off |

DISCLAIMER: At the time of print, this manual is accurate in its information. Coast Spas reserves all the rights to change/modify any spa designs and/or features without notification. To check on updates or for other information, please visit www.coastspas.com

THE CASCADE II SPA INCLUDES

Choose model to see specific features and options. All features below may not be included with all models.



Extreme XL Water Diverters LED. Divert the flow of water to specific seats in your Spa.



Air Controls. Allow air to mix with the water being supplied to your massage jets.



Our **Luxury Trillium Jets** are made to deliver the ultimate hydrotherapy experience.



Streaming water ropes provides the soothing sound of running water. Adds a stunning look to the profile of the Spa.



Coast Spas have developed the **Hydro Cyclonic Filtration System®**. Not only is it more efficient and faster than a skim filtration system but it also removes the dirty filter canisters from the bathing area.



Your Spa has the ability to be equipped with the **Worldwide Spa Remote** hardware that is required to take advantage of nearly limitless control and monitoring of your Spa.



The Coast Spas exclusive **24" waterfall** is the largest available on any Hot Tub. Enjoyment is guaranteed.



Coast Spas saves you all the trouble and money with the **Self-Cleaning Sweeper Jet**. The Sweeper Jet is positioned near the spa floor with its fan-like nozzle aimed downwards, and is automatically activated on daily filtration cycles.



In a Coast Spas® Cascade Series Spa, the water level will always stay the same regardless of how many people are in the Spa.



The raised back of our Curve and Cascade models shelter you from the wind as well as provide a private area in your Spa.



A Cascade Spa uses the Infinity Edge as the skimmer to remove debris from the surface of the water, leaving the rest of the Hot Tub with only quiet, open seating.



Coast spas is proud to offer the largest skimmer in the industry, this allows our Spas to remove debris from the surface of the Spa and help to control foaming.



A self purging pump eliminates the hassle of having to manually bleeding air from pumps and lines.



Digital Float and Fill Gauge: The illuminated fill gauge for all Cascade Series Spas takes the guesswork out of filling the overflow tank.

SPA COMFORTS

- Plush Headrests
- Beverage Holders
- Anti-Slip Textured Floor
- Ergonomic Seating
- Multi-Level Seating
- Large Foot wells
- Programmable Filtration

DISCLAIMER: The pictures displayed above are for reference purpose only. Some parts may be different depending upon the spa model.

DISCLAIMER: At the time of print, this manual is accurate in its information. Coast Spas reserves all the rights to change/modify any spa designs and/or features without notification. To check on updates or for other information, please visit www.coastspas.com.

PREP FOR FILLING

! PLEASE READ ALL INSTRUCTIONS BELOW BEFORE FILLING THE SPA



Using a cloth and water, wipe away any dirt/dust collected from transport. Ensure all jets are open by turning the face counter clockwise.



If your spa has a Crystal Clear tube the threaded plug needs to be on prior to filling the spa.



Remove the filter lock ring and lid. Remove filter and take it out of the plastic transport bag.



Put the filter back inside and secure the lid firmly with the locking ring. Loosen air-bleed screw.

FILLING YOUR SPA

! DO NOT USE HOT WATER TO FILL YOUR SPA

! DO NOT USE WATER FROM A WATER SOFTENER



Place fill hose inside the spa and fill main body of spa with water until it reaches the infinity edge. Allow water to spill over infinity edge for approximately 60 seconds.



Tighten air-bleed screw.



Turn power to the spa on from GFCI breaker to activate water level gauge. Continue filling until the water gauge reads just below 1/2 full.



Turn power to the spa off from the GFCI breaker for 30 seconds and then turn back on.

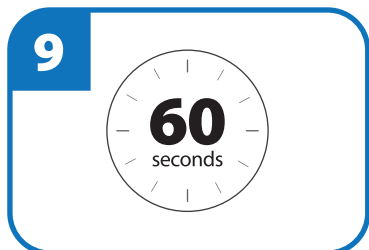

Do not press the back and/or pump #1 button on the control panel. Activate high speed on pumps 2 & 3 (if 3-pump model) or pump 2 (if 2-pump model) by pressing the pump buttons twice. Let run for 60 seconds.

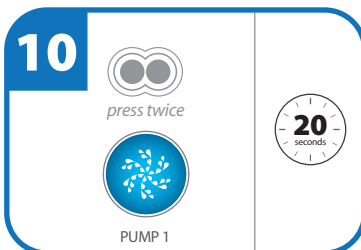

Continue running pumps 2 & 3 (pump 2 on 2-pump models), turn pump 1 on high speed for 20 seconds by pressing the pump 1 icon twice.

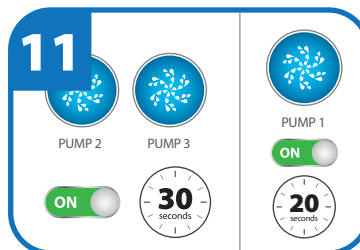

Continue running pumps 2 & 3 (pump 2 on 2-pump models) on high speed for 30 seconds and activate pump 1 on high speed for 20 seconds.



Cascade check valve inside the equipment area, full of water is an indication of no more air in the plumbing line. If the check valve is not full of water, air is still in the plumbing lines.



Release any additional trapped air by loosening the air bleed screw. Wait for all air to be released. Retighten.

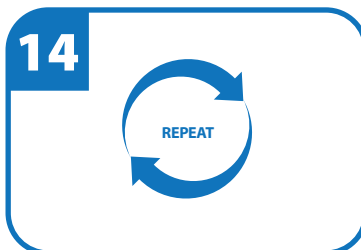

Repeat steps 11-12 until all air has been removed from the system. If air is still in the system it will precede water coming out of the jets when pump 1 is activated.

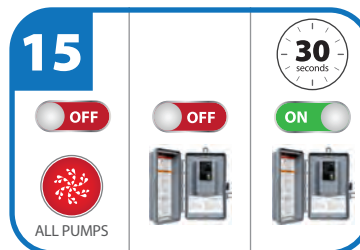

Turn off all pumps. Then turn main power off to the spa for 30 seconds. Then turn power back on.

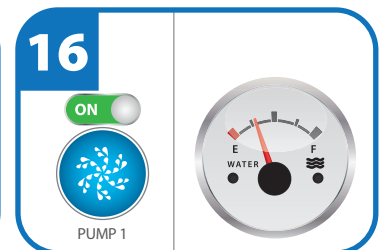

Your water level should read just above 1/4 full on the gauge when pump 1 (high speed) is activated. **Your hot tub is now filled. Set the temperature and get ready to enjoy!**

SPA CARE GUIDE

Your Authorized Dealer carries a wide variety of care and maintenance products. For more information please contact your Dealer.

REQUIRED FILTER MAINTENANCE

Your new Cascade Spa is equipped with a filter cartridge. To ensure maximum water quality at all times, you should replace the filter cartridge every six months, or earlier as necessary. The filter cartridge is designed to be thrown away! Attempts to re-use the filter cartridge may result in the re-release of unwanted particles back into the Cascade Spa.

PLEATCO DUAL CORE FILTERS

Your Cascade Spa/spa comes with a premium filter. Most come with equipped with a Pleatco DualCore Filter, which does a better job of cleaning your spa water than any other filter cartridge. The DualCore filter has two layers of filtration media, the outer layer and the inner layer. Both are engineered to remove different particles from your water.



The outer core is similar to a traditional filter which traps larger debris, while the inner core filters the water for particles down to 3 microns in size. The inner core is easily removed and both filter media can be cleaned.

Keeping your spa water clean and refreshing is extremely important for your enjoyment of your Cascade Spa. Our Cascade Spas come with only the best filters available in order to ensure your satisfaction.

REQUIRED WATER REPLACEMENT

You should replace the Cascade Spa's water every 3-6 months. The frequency will depend on a number of variables including frequency of use, number of bathers and attention paid to the water quality maintenance. You will know it is time for a change when you can no longer get the normal feel or sparkle to the water, even though the key water balance measurements are all within the recommended ranges.

HEADREST / PILLOW CARE

The pillows can be removed for easy cleaning and maintenance. All pillows have plugs within the pillow itself. To remove the pillow, grab the bottom edge firmly and pull outward.

This will allow the pillows to pop-out from the receptacle in the spa shell. To reinstall the pillow you will align the pillow plug with the receptacle. Press/hit the front side of the pillow firmly, which will insert the plug back into the receptacle.

- **Proper water chemistry must be maintained. Your Cascade Spa pillows are easily and quickly damaged when exposed to unbalanced spa water.** If you suspect that your chemicals may be unbalanced, remove your pillows immediately until the water has been restored to suggested conditions.
- Do not sit on the pillows
- Do not pull on the pillows
- Pillows should be cleaned using a soft cloth and mild soap, then wiped with a conditioner. We recommend that pillows be washed each time you drain you spa.

This Limited Warranty is void if failure is caused by accident, acts of nature, acts of God, or other causes beyond the control of CSMI. Neglect, misuse and abuse include any installation, operation, or maintenance of the spa other than in accordance with the instructions contained in the owner's manual provided with the spa, including, but not limited to damage caused by operation outside the range of 34 degrees Fahrenheit and 116 degrees Fahrenheit or 1 degree Celsius and 47 degrees Celsius.

Please be advised that the Spa Warranty will become void if Coast Spas or any of its selling or servicing agents determines that the spa has been exposed to Hydrogen Peroxide, TriChlor or any substance using it as an ingredient proven to be dangerous to the Spa. Any condition arising from the use of Hydrogen Peroxide or TriChlor on the spa is not a warrantable defect.

CASCADE SPA INTERIOR

Your Cascade Spa has a fiberglass reinforced acrylic shell. Generally dirt and stains will not adhere to the surface. To properly clean the surface, we recommend wiping it with a soft damp cloth (or sponge) using a low sudsing household soap or liquid detergent and rinsing thoroughly with fresh water. Stubborn dirt or stains may be removed by using Spic & Span adequately dissolved in water. Contact your dealer and inquire about maintenance packages.

DO NOT use any cleaning products containing abrasives or solvents, since these could damage the surface. Harsh chemicals should never be used on acrylic surfaces. Damage to the shell due to the use of harsh chemicals is not covered under the warranty.

DO NOT leave your Cascade Spa drained and in direct sunlight for extended periods of time. Extreme heat could cause damage to the acrylic surface and may induce an effect known as "crazing".

STAINLESS STEEL CONTROLS AND COMPONENTS ABOVE THE WATER LINE

To preserve the stainless steel finish of the controls and components above the water line, we recommend they be wiped with a dry soft cloth after each use of your Cascade Spa. In addition, off-gas your spa by removing the cover for approximately 30 minutes multiple times per week (if not in use) and after every shock treatment.

CABINET CARE

Never spray cabinets with a high-pressure garden hose or pressure washer for any reason. This action may induce an electrical short in the Cascade Spa's electrical equipment.

VINYL CABINET

Vinyl cabinets are made of a rigid polymer that combines the durability of plastic with the beauty of real wood. This cabinet is manufactured so that it won't crack, peel, blister or delaminate even after prolonged exposure to the elements. We recommend wiping the cabinet with a soft damp cloth (or sponge) using household soap or liquid detergent and rinsing with fresh water thoroughly. **DO NOT** use abrasive cleansers or material as this may damage the surface.

Vinyl cabinet door opening instructions



SLATE CABINETS

Optional Slate cabinets are custom-built and painted in our factory. We recommend lightly brushing the cabinet with a **SOFT** bristle brush to remove any dirt or stains. For more information on the care of your Slate cabinet, please contact your Local Dealer.

Slate cabinet door opening instructions



COVER CARE

A well cared for spa cover is a thing of beauty in its own right. Be sure to clean and condition your cover at least once a month – more often if needed. Your cover needs to be cleaned and conditioned because vinyl can be dry and become brittle, spoiling your spa's appearance. Dry, brittle vinyl can also tear at the seams and stress points. Quality materials, internal sewn reinforcing and careful workmanship can only go so far against the ravages of Mother Nature. See the specific Warranty card enclosed with your cover for further details.

- When you shock your spa you need to remove the cover for a minimum of 30 minutes to ensure that the chemical gas off can escape from the spa.
- You are required to keep the spa covered at all time when not in use to protect the shell from harmful UV rays.
- A covered spa will use less electricity when maintaining the desired water temperature.
- See the manual that comes with the cover for proper mounting of the cover locks.
- The cover should remain locked at all times to prevent unauthorized entry into the spa and potential drowning.
- Do not Sit, Stand or Lie on your cover. Nor should you place any heavy object on top of the cover as this may damage the structure.

VERY IMPORTANT: We recommend a vinyl conditioner for your spa cover. Your local dealer carries a wide variety of care and maintenance products. Choose a pleasant day each month to remove your cover from the spa and lay it on a flat surface accessible by garden hose. Douse the cover with a healthy amount of water from the hose or a bucket to rinse away loose dirt or debris. Using a soft bristle brush and a mild solution of dishwashing liquid (about one teaspoon of detergent to two gallons of water), and with a gentle circular motion, scrub the cover clean. Be careful not to let any areas of the cover dry before they're thoroughly rinsed.

Now apply the vinyl conditioner as directed on the container. Massage the conditioner into the cover in a gentle but firm manner. Before replacing the cover on your spa, wipe and rinse any dirt from the bottom of the cover. When you are ready, put the cover on the spa.

NOTE: To remove tree sap, use lighter fluid (not charcoal lighter but the fluid used in cigarette lighters). Use sparingly, then immediately apply conditioner to that area. All waterfalls and laminar flow water features should be turned off when the spa is not in use to avoid heat and water loss.



BASIC INSTALLATION AND CONFIGURATION GUIDELINES

WARNING! Qualified Technician Required for Service and Installation

ELECTRICAL REQUIREMENTS

All self contained spas use 120VAC or 240VAC electrical spa packs. These instructions describe the only acceptable electrical wiring procedures. Spas wired in any other way will void your warranty and may result in serious injury. All installations should be completed by a certified electrician. Failure to comply with state and local codes may result in fire or personal injury and will be the sole responsibility of the spa owner.

120VAC: This requires an isolated 15 Amp circuit breaker. This needs to be an isolated circuit with no other appliances or lights on this circuit at any time. Extension cords are not to be used in conjunction with the operations of the spa. Low voltage damage could result and this is not covered by warranty.

NOTE: All components must be 120V; No 240V components allowable.

240VAC: Depending on the model of spa, it will require either a 40 Amp, 50 Amp, or 60 Amp dedicated circuit breaker, GFCI, with the proper wire size based on the length of the run. The electrical circuit must be installed by a certified electrician and approved by a local building or electrical inspector.

Use minimum 6AWG copper conductors only. Torque field connections between 21 and 23 in lbs. Readily accessible disconnecting means to be provided at time of installation. Permanently connected power supply.

Connect only to a circuit protected by a Class A Ground Fault Circuit Interrupter (GFCI) or Residual Current Device (RCD) mounted at least 5' (1.52M) from the inside walls of the spa/Cascade Spa and in line of sight from the equipment compartment.

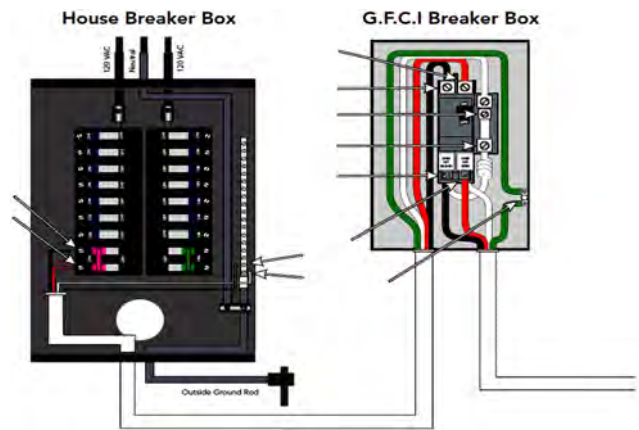

INFINITY SPAS AMP CHART							
SERIES	JETS	PUMPS	VOLTAGE	AMPERAGE	FREQUENCY	CIRCUIT BREAKER	MAX FLOW RATE
CASCADE II	61	3 x 5HP	240	48	60	60	91

DISCLAIMER: There are no user serviceable parts in the GFCI compartment. All the services and repairs should be performed by certified electrician.

OWNER'S MANUAL

Refer to Wiring Diagram inside the cover of the control enclosure. Refer to Installation and Safety Instructions provided by the spa manufacturer.

WARNING! GFCI OR RCD PROTECTION. The Owner should test and reset the GFCI or RCD on a regular basis to verify its function.

WARNING! Do not attempt service of this control system. Contact your dealer or service organization for assistance. Follow all owner's manual power connection instructions. Installation must be performed by a licensed electrician and all grounding connections must be properly installed. Disconnect the electric power before servicing. Keep access door closed.

CAUTION:

- List of safety instructions in Chinese characters.

WARNING:

- Warning instructions in Chinese characters.

CAUTION: Y @) A * a * A c a n d b e f A ~ q { ^ } c a s e b A . a e c] ! ^ s e c } . A @ ~ j a s e , s e . h a f j | | , a e

INFINITY SPA MAINTENANCE PROCEDURES

OWNER'S MANUAL

V @ A) a q c ! h A) ^ A ~ A c @ A [. o h] [i c e y e s e c } a e h e n { . A ~ A a O a e s a A U) a n V @ A q c ! h A c o ! ^ A t A n { [c a h a i a A t { A c @ A j a e ! A e j a A ^ a A t A h A h e j a A) A a A ~ j a s a e a e O e a j ! ^ A t A h A t A j a e A ! a ~ j o h A j [i A t i t { e a e n j [i A a e ! A h e s e A e j a h y ~ j a A j ^ c a } o c @ A) a n { { A @ a e j * e O e d a e j } A e s o A e A e [] A e A h , A a A e a n A c @ ~ * A c @ A q c ! e O A c @ A q c ! A s e d a e * A h { [c a A c @ A a i a A t { A c @ A) a e a e h o A e s { ~ j a e a h a i a A e e . h A j , A . a e e e h e n

CLEANING AND REPLACING FILTER CARTRIDGE

Y [~ ! A .] a q c ! A c e A a ^) A a . a) ^ a A t ! A ~ a A e j a A ^ a A { e s e c } a e h e n V @ A q c ! A s e d a e * A . @ ~ j a A a A i a j . h a A a ^ A c @ . h A [] h A a A , h A A a j a A h e j a A , a O a e s a e d a e * A h e j a h A j { } h A a A { [] c e h a . h e j } a A q c ! A s e d a e * A h A A i h e j { { ^ } a a A a e j a A , a j A . j ^ a A) A c @ A j ! [h . . e n V @ A e j A h A j ~ ! e h e a A t { A t ~ ! A j e s A a h e j ! e n



TOP LOAD FILTERS

- List of instructions for cleaning and replacing the filter cartridge in Chinese characters.

NOTE: T a e ^ A ~ ! A c @ A U e j a * h A j) A c @ A a h A i a A q a c h e n j a a h a j * A i A e a j ! a t A t A e s e j * A c @ A j { } e n V @ A U e j a * A . @ ~ j a] ! a j a e h e n h e h a j a i a e e a a a a e h a j a h j ^ h A i a e e e e

WATER QUALITY MAINTENANCE

Maintaining the quality of the water within the specified limits will serve to enhance your enjoyment and prolong the life of the Cascade Spa's equipment. It is a fairly simple task, but it requires regular attention because the water chemistry involved is a balance of several factors. There is no simple formula, and there is no avoiding it. An indifferent approach to water maintenance will result in poor and potentially harmful conditions for soaking and even damage to your Cascade Spa investment. The most important thing to keep in mind is that *preventing* poor water chemistry is much easier than *correcting* poor water chemistry. For specific guidance on maintaining water quality, consult your Authorized Dealer who can recommend appropriate chemical products for sanitizing and maintaining your Cascade Spa.

MAINTAIN HEALTHY SPA WATER

Important! When maintaining your Cascade Spa's water chemistry, ensure that your cover is removed during any aggressive treatments to allow for dissipation into the air. Take care to remove the cover slowly and let chemicals deplete if you are uncertain if your water is properly balanced. ***Always maintain your Cascade Spa's water chemistry within the following parameters:***

pH: pH is a measure of relative acidity or alkalinity of water and is measured on a scale of 0 to 14. The midpoint of 7 is said to be neutral, above which is alkaline and below which is acidic. In Cascade Spa water, it is very important to maintain a slightly alkaline condition of 7.2 to 7.8. Problems become proportionately severe the further outside of this range the water gets. A low pH will be corrosive to metals in the Cascade Spa equipment. A high pH will cause minerals to deposit on the interior surface (scaling), cloudy water, and a prematurely dirty filter. In addition, the ability of the sanitation agents to keep the Cascade Spa clean is severely affected as the pH moves beyond the ideal range. That is why almost all Cascade Spa water test kits contain a measure for pH as well as sanitizer. **DO NOT** use strong acids like Hydrochloric acids or Muriatic acid to balance the pH as it could severely damage the spa shell.

Sanitizer (Chlorine or Bromine): To destroy bacteria and organic compounds in the Cascade Spa water by breaking them down into non-harmful levels which get filtered out. A sanitizer must be used regularly, either chlorine or bromine. Sanitizing your spa water is the most important spa maintenance you can do for yourself.

Total Alkalinity (TA) is the measure of the dissolved alkaline agents such as carbonates and bicarbonates. These alkaline agents help prevent rapid changes in pH by acting as a pH buffer.

Controlling alkalinity can help keep your pH in the appropriate range thereby lessening the need for pH balancing. If the TA is too low the pH level will fluctuate rapidly from high to low. If the TA is too high the pH will tend to be too high and will be very difficult to bring back down.

Calcium Hardness: This is a measurement of dissolved calcium in the water. Calcium will help control the corrosive nature of the spa's water. Low calcium hardness causes spa and equipment corrosion whereas high calcium hardness results in cloudy water and scale build-up on the spa and the equipments.

WARNING: Never store chemicals inside the equipment area of your spa.

IMPORTANT: DO NOT use Hydrogen Peroxide based sanitizers in your spa. When using Chlorine or Bromine tablets you must use a floating dispenser. These chemicals can have an extremely corrosive effect on certain materials in the spa. Damage caused by use of these chemicals, or improper use of any chemicals, is not covered under the spa's warranty.

OTHER ADDITIVES: Many other additives are available for your spa. Some are necessary to compensate for out-of-balance water, some aid in cosmetic water treatment and others simply alter the feel or smell of the water. Your Authorized Dealer can advise you on the use of these additives.



Look for these specialized cleaning attachments at your local dealership.

WATER DIVERTER MAINTENANCE

CAUTION: Turn off the spa from main GFCI breaker to carry out any maintenance procedures.

Steps to clean water diverters:

1. Pull the diverter cap off and rotate the diverter body counter clock wise and pull out the assembly (Picture 1a to 1c).
2. Using clean piece of cloth, remove the dust particles or depositions (Picture 2).

3. Assemble the diverter body by inserting the body back by rotating the jet body clock-wise (Picture 3a and 3b). Attach the diverter cap.

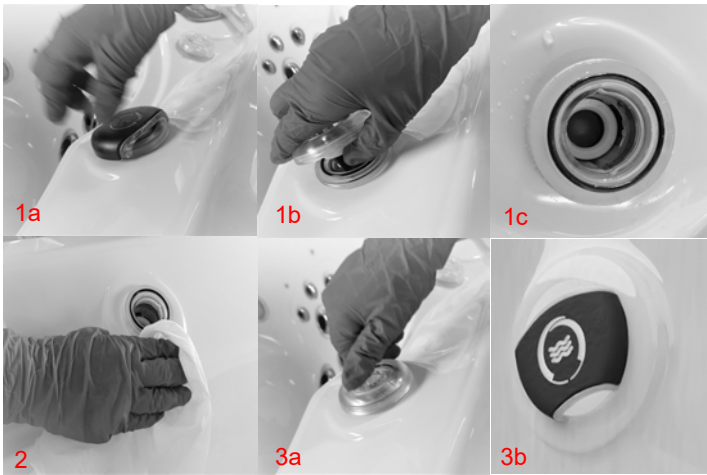

JET MAINTENANCE

CAUTION: Turn off the spa from main GFCI breaker to carry out any maintenance procedures.

It is important to regularly clean the jets to prevent any unwanted depositions and potential damage to the plumbing. It is the responsibility of the customer to regularly perform the maintenance procedures. To clean and maintain optimum jet functions, follow the maintenance instructions below.

LAMINAR FLOW JET MAINTENANCE INSTRUCTIONS

1. Rotate counter clock wise and pull out the jet body (Picture 1a and 1b).
2. Using clean piece of cloth, remove the dust particles or debris (Picture 2).
3. Remove the unreachable debris with the help of vacuum cleaner (Picture 3).
4. Assemble the jet insert back by rotating the jet body clock-wise (Picture 4a and 4b).

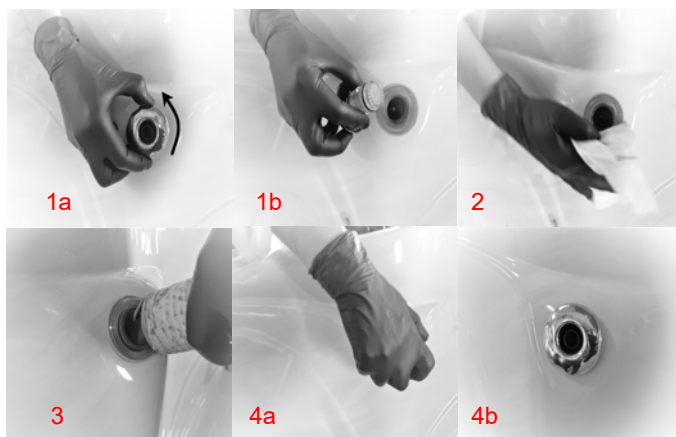

WATER CLARITY TROUBLESHOOTING

PROBLEM	PROBABLE CAUSE	POTENTIAL SOLUTIONS
Water Odor	<ul style="list-style-type: none"> • Improper sanitization • Excessive organics in water • pH is too low 	<ul style="list-style-type: none"> > Add sanitizer > Shock spa with sanitizer > Adjust pH
Chlorine Odor	<ul style="list-style-type: none"> • Chloramines are too high • pH is too low 	<ul style="list-style-type: none"> > Shock spa with sanitizer > Adjust pH
Musty Odor	<ul style="list-style-type: none"> • Bacteria or Algae growth 	<ul style="list-style-type: none"> > Shock spa with sanitizer > Drain and refill spa water
Scale	<ul style="list-style-type: none"> • Total alkalinity is too high • pH is too high • High calcium content in water 	<ul style="list-style-type: none"> > Adjust total alkalinity > Adjust pH > Use stain and scale product
Stains	<ul style="list-style-type: none"> • Total alkalinity is too low • pH is too low • High metal content in water 	<ul style="list-style-type: none"> > Adjust alkalinity > Adjust pH > Use stain and scale product
Cloudy Water	<ul style="list-style-type: none"> • Poor filtration • pH is too high • Hardness is too high • Total alkalinity is too high • Suspended particles 	<ul style="list-style-type: none"> > Clean filter cartridge > Adjust pH > Adjust hardness > Adjust total alkalinity > Drain and refill spa water
Algae Growth	<ul style="list-style-type: none"> • pH is too high • Sanitizer is too low 	<ul style="list-style-type: none"> > Adjust pH > Shock spa with sanitizer > Adjust sanitizer level
Eye Irritation	<ul style="list-style-type: none"> • pH is too low • Sanitizer is too low 	<ul style="list-style-type: none"> > Adjust pH > Shock spa with sanitizer > Adjust sanitizer level
Skin Rash/Irritation	<ul style="list-style-type: none"> • Free chlorine level too high • Unsanitary water 	<ul style="list-style-type: none"> > Adjust chlorine level > Shock spa with sanitizer > Adjust sanitizer level

TROUBLESHOOTING GUIDE

SPA SYSTEM

SYMPTOM	PROBABLE CAUSE	RECOMMENDED ACTION
Spa does not work	<ul style="list-style-type: none"> Power is turned off 	<ul style="list-style-type: none"> > Reset GFCI
No display on the control panel	<ul style="list-style-type: none"> Power is turned off Defective topside control 	<ul style="list-style-type: none"> > Reset GFCI > Contact your Dealer
Letters on the control panel	<ul style="list-style-type: none"> An error has been found 	<ul style="list-style-type: none"> > Refer to the Reference Card for your control panel to verify the error. Contact your Dealer for service

PUMP PROBLEMS

SYMPTOM	PROBABLE CAUSE	RECOMMENDED ACTION
Noisy/Loud motor	<ul style="list-style-type: none"> Air trapped in the pump Low water level Worn pump seal Defective pump 	<ul style="list-style-type: none"> > Open bleed valve in the skimmer > Add water to the spa > Contact your Dealer > Contact your Dealer
Pumps power down on their own	<ul style="list-style-type: none"> Set temperature has been reached Filtration cycle has ended Automatic time out Overheat safety protection 	<ul style="list-style-type: none"> > No problem > No problem > Pumps are set to run for a predetermined time while the spa is in use (15-20 Mins) > The pumps have a thermal overload which will prevent them from running for extended periods of time. Wait until pumps have cooled down (1+ hrs). If problem persists, contact your Dealer.
Pump running constantly, will not turn off	<ul style="list-style-type: none"> Filter cycle set to 24 hours Problem with the circuit board 	<ul style="list-style-type: none"> > Turn off 24 hour filtration > Turn power off at GFCI and contact your Dealer
Pump will not turn on	<ul style="list-style-type: none"> GFCI tripped Motor has overheated Not plugged in Damaged plug Seized motor Blown fuse Motor vent is blocked 	<ul style="list-style-type: none"> > Reset the GFCI > Let cool for 1+ hour > Plug in to the board > Contact your Dealer > Contact your Dealer > Check fuse or contact your Dealer > Clear debris from the vent

HEAT PROBLEMS	PROBABLE CAUSE	RECOMMENDED ACTION
Water will not heat	<ul style="list-style-type: none"> • Error message on control panel • Spa is in a different Heat Mode • Water level is too low • Poor water flow • Closed valves • Pump 1 is not running 	<ul style="list-style-type: none"> > Refer to the Reference Card for your control panel to verify the error > Set spa to "Standard Mode" > Add water to the spa > Clean filter & check valves > Open all valves > Contact your dealer
Water is too hot	<ul style="list-style-type: none"> • Incorrect reading • Filter cycle duration is too long • Pump speeds reversed 	<ul style="list-style-type: none"> > Verify temperature with thermometer > Reduce duration of the filter cycle > Contact your dealer
Water will not maintain heat	<ul style="list-style-type: none"> • Cover is off for extended periods of time in cold weather / cold wind. • Hot tub is wired for 110V and jets are on. 	<ul style="list-style-type: none"> > Put cover back onto hot tub and allow for heat to regenerate. Call your dealer if temperature does not increase. > Hot tubs wired for 110V only have enough power to heat or operate pumps. Turn off jets to power heater.

LIGHTING ISSUES	PROBABLE CAUSE	RECOMMENDED ACTION
Standard light will not come on	<ul style="list-style-type: none"> • Bulb has burnt out 	<ul style="list-style-type: none"> > Replace the light bulb
LED lighting not in sync	<ul style="list-style-type: none"> • Burnt out bulb/connection 	<ul style="list-style-type: none"> > Contact your dealer
LED lighting won't come on	<ul style="list-style-type: none"> • Incorrect settings 	<ul style="list-style-type: none"> > Contact your dealer

PUMPS WILL NOT PRIME	PROBABLE CAUSE	RECOMMENDED ACTION
Pump on but no water flow	<ul style="list-style-type: none"> • Air trapped in pump • No water in the pump • Closed valves 	<ul style="list-style-type: none"> > Loosen bleed valve in skimmer > Check the fill level in the spa > Open all valves

HYDROTHERAPY JETS	PROBABLE CAUSE	RECOMMENDED ACTION
Little to no water flowing from jets	<ul style="list-style-type: none"> • Jets turned off • Pump not primed • Valves are closed • Diverter set to a different seat • Dirty filter 	<ul style="list-style-type: none"> > Open jet by turning the face counter clockwise > Reset breaker to allow for the spa to prime the pump. Open bleed valve in the skimmer area > Open valves > Switch diverter > Remove and clean filter cartridge

PLUMBING SYSTEM	PROBABLE CAUSE	RECOMMENDED ACTION
Water around base of spa	<ul style="list-style-type: none"> • Loose connections • Leak from internal fitting 	<ul style="list-style-type: none"> > Hand tighten all quick disconnects and fittings. > Check gaskets and O-rings > Contact your dealer

DRAINING AND WINTERIZING

DRAINING YOUR SPA

After a period of 3-4 months, detergent residues from bathing suits and soap film will build up in your spa water. Once this happens, your spa water will appear cloudy and should probably be replaced.

- Turn power OFF at the breaker.
- Locate the Drain Valve(s) – Two drain valves (one for spa and other for the tank) usually located in the equipment area, could be installed unless a Water-Evac system is present.
- Remove the safety cap and attach garden hose.
- Drain water to a convenient area. (Spa water may harm grass or plants if sanitizer levels are high.)
- When water begins to flow out of the hose, open the air relief valve located on filter lid (Hydro-Cyclonic Filtration) or Air Bleeder Valve (Skim Filtration).
- Your spa will drain except for a small portion left in the foot well. This can be removed with a sponge and pail.
- Once empty, clean as required.
- To finish, remove garden hose and attach safety cap.

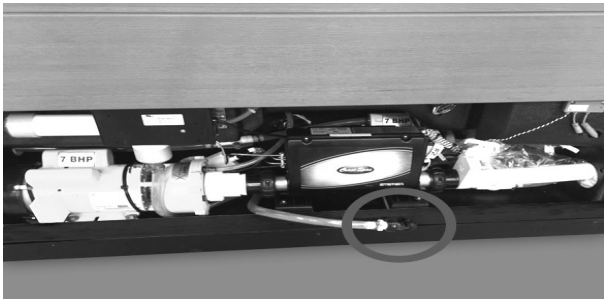

WINTERIZING YOUR SPA

In many areas of the world the temperature may drop below 32° F (0°C). We recommend the spa is always filled with water and running at normal spa temperatures. By doing this you will minimize the risk of freezing within your spa. If it is necessary to leave your spa unattended for long periods of time during cold weather conditions, you should drain your spa to avoid accidental freezing caused by power outages.

Your local dealer can perform the following winterizing procedures, if you are not completely comfortable with them.

- Ensure that you have fully drained the spa (Refer to the DRAINING YOUR SPA section)
- After draining, your spa may still have water remaining in the equipment and plumbing fittings. Disconnect the hand-tightened union fittings going to and from the jet pumps. Be careful not to lose the O-rings between the unions and pump housing.

- Leave drain valve in the open position and safety cap off .
- To completely drain the plumbing lines, a wet/dry shop vacuum can be used to draw out any remaining water. Place the vacuum hose over the jet fittings in the spa as well as the plumbing lines in the equipment area. You should also disconnect the plug on the crystal clear inspection tube (if installed)
- Remove the filter cartridge and store in a warm, dry area.
- Clean the spa shell and place spa cover on spa. Be sure to lock the cover in place in case of high winds or rain.

WARNING: The instructions above should be followed accordingly when winterizing your spa however they are guidelines and potential freeze damage may still occur. All freeze damage is the sole responsibility of the spa owner and will not be covered by the warranty should it occur.

EMERGENCY SITUATIONS: To eliminate freezing in the event of equipment failure, use a 100-watt light bulb or small heater via extension cord and place it in the equipment area, keeping it away from plumbing lines. This will help for a short period of time until proper service can be rendered.



DRAINING INSTRUCTIONS

1. On the control panel (settings) select **hold**. This will suspend all functions so that the spa can start to be drained.
2. Remove the false bottom in cabinet area.
3. Connect your hose to the hose bib located in the lower compartment. Open the hose bib valve until water starts coming out of the drain hose.
4. Turn evacuation pump power switch ON - located at the top left of the enclosure.
5. The length of time it will take to drain depends on the size of your spa. On average it will take approximately 1 hour.

If you have an Infinity Edge Spa allow it to drain for 30 minutes and then take it off of **hold**. Pump 1 will run on low speed to drain the tank into the main body of the spa.

Let pump 1 run on low speed until the water stops coming out of the jets/waterfall and immediately put the system back into **hold** (refer to step one).

6. Allow spa to finish draining. When fully drained, switch off the evacuation pump and close the hose bib valve.
7. Switch off power to the spa via the main GFCI Breaker.
8. You may have to use a shop vacuum to remove any excess water. Clean the spa before refilling. Refer to your Owner's Manual for proper filling instructions. Once the spa is filled, **prior to adding chemicals**, open the hose bib valve for approx. 15 seconds to allow fresh water to flush the Water-Vac™ System then close the hose bib valve.

IMPORTANT PLEASE READ

Do not leave your spa unattended while draining. After 90 minutes the hold function is disabled and will allow your spa pumps to activate. This could cause damage to your equipment.

INFINITY SPA JET OPERATIONS CASCADE II 61 JETS

	PUMP 1
	PUMP 2
	PUMP 3

JET Note:

∅	= Cluster Jet
R	= Poly Jet
2K	= Storm Jet
2KV	= Volcano Jet



Fusion W.F. & L.F. Shutoff

ON () OFF (BLUE)

(Optional C.C. Shutoff)

ON () OFF (BLUE)

Diverter Control

 = Green (Right)
 = Magenta (Left)

Air Control General Note:

ON () OFF (BLUE, ORANGE, GREEN, MAGENTA)

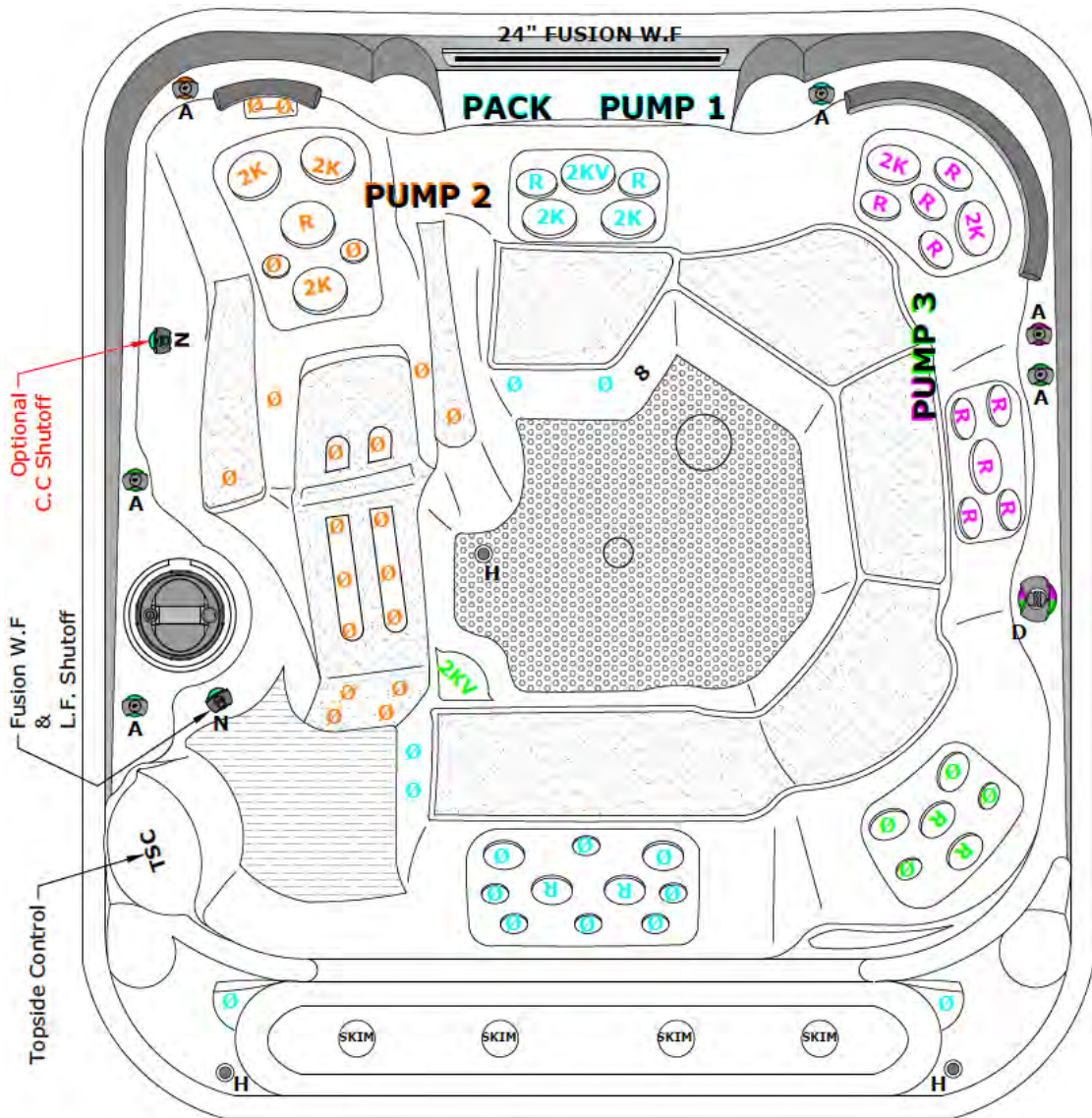

DISCLAIMER: At the time of print, this manual is accurate in its information. Coast Spas reserves all the rights to change/modify any spa designs and/or features without notification. To check on updates or for other information, please visit www.coastspas.com

INFINITY SPA JET OPERATIONS CASCADE II 61 JETS WITH AQUASOLE

	PUMP 1
	PUMP 2
	PUMP 3

JET Note:

Ø	= Cluster Jet
R	= Poly Jet
2K	= Storm Jet
2KV	= Volcano Jet
	= AquaSole

Fusion W.F. & L.F. Shutoff

ON  OFF
(BLUE)

(Optional C.C Shutoff)

ON  OFF
(BLUE)

Diverter Control

 = Green (Right)
= Magenta (Left)

Air Control General Note:

ON  OFF
(BLUE, ORANGE, GREEN, MAGENTA)

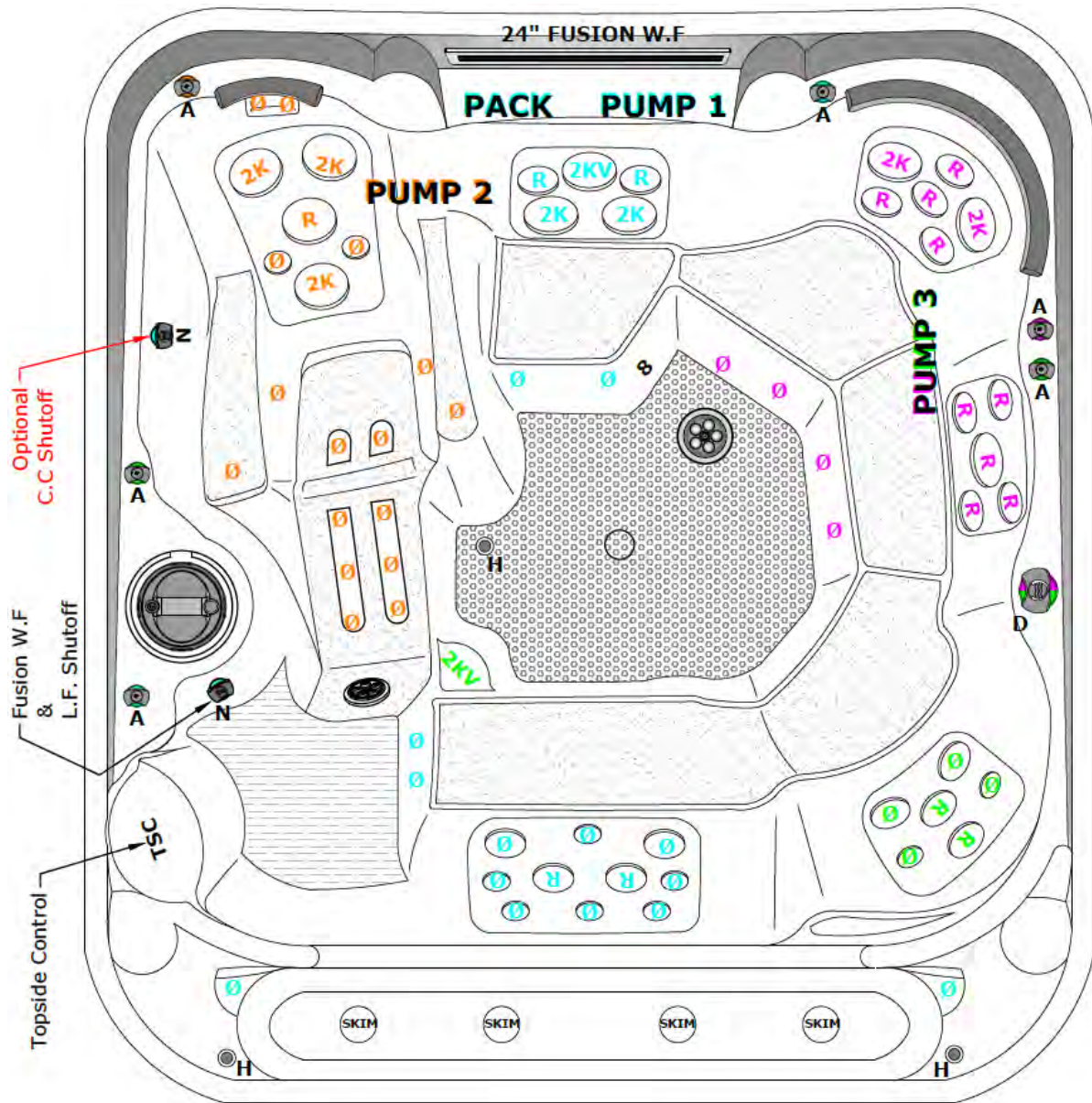

DISCLAIMER: At the time of print, this manual is accurate in its information. Coast Spas reserves all the rights to change/modify any spa designs and/or features without notification. To check on updates or for other information, please visit www.coastspas.com

CASCADE II SPECIFICATIONS

Model	Seats	Water Capacity (L)	Water Capacity (US Gal)	Dry Weight (lbs)	Dry Weight (kg)	Wet Weight (lbs)	Wet Weight (kg)	Dimensions (cm)	Dimensions (inches)
Cascade II	6 to 7	1817	480	1477	670	5485	2488	233.7 x 256.5 x 79 (119.5 at back)	92 x 101 x 31 (47 at back)

DISCLAIMER: At the time of print, this manual is accurate in its information. Coast Spas reserves all the rights to change/modify any spa designs and/or features without notification. To check on updates or for other information, please visit www.coastspas.com

CASCADE II SPA CONTROL PANEL



The Main Screen

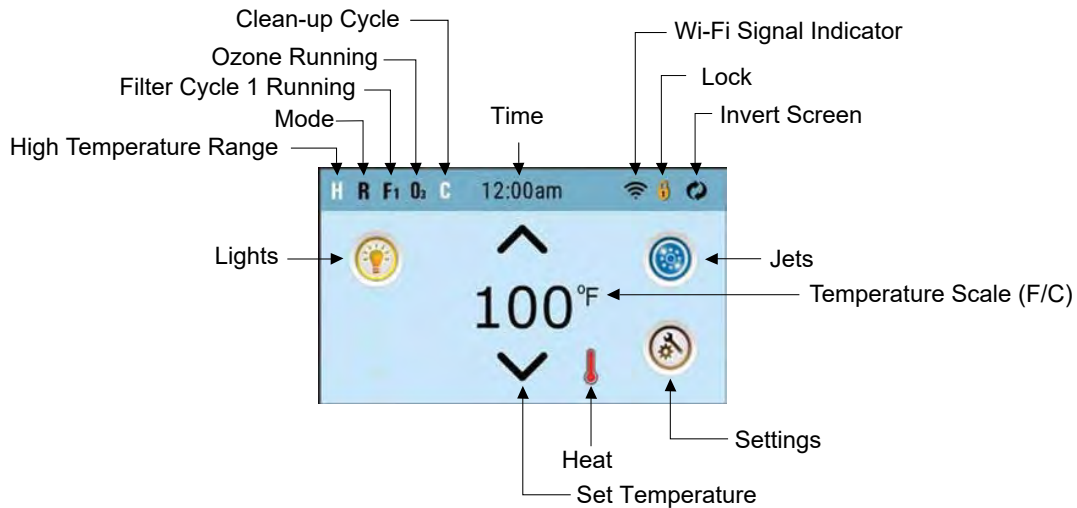

SPA STATUS

Important information about spa operation can be seen on the Main Screen. Most features, including Set Temperature adjustment, can be accessed from this screen. The actual water temperature can be seen, and the Set Temperature can be adjusted (see page 5). Time-of-Day, Ozone and Filter status is available, along with other messages and alerts. The selected Temperature Range is indicated in the upper left corner. The Spa Equipment Control Icon will spin if any pump is running. A Lock icon is visible if the panel or settings are locked.

Note: After 30 minutes* the display will automatically go into sleep mode, which turns the display off. This is normal operation. Touch anywhere on the screen to wake the panel up.

- H = High Temperature Range
L = Low Temperature Range

- R = Ready Mode | RR = Ready/Rest Mode
⌞ = Rest Mode

- F1 = Filter Cycle 1 is running
● F2 = Filter Cycle 2 is running
● F+ = Filter Cycles 1 & 2 are both running



- O3 = Ozone is running. If you don't see the icon that means the Ozone is OFF.

- C = Clean-up cycle is running.
Note: Not all systems that can run a Cleanup Cycle display this icon.

-  Wi-Fi icon just indicates that the Wi-Fi ink is connected.

-  Invert (or flip) Screen



Lock Icon: When displayed, indicates the panel is in a locked mode. To un-lock or lock a setting or panel lock, first press the corresponding icon on the Lock Screen, then press and hold the word "Lock" for 5+ seconds until the text and icon change to the opposite state.





There are 2 lock icons that can be shown on the title bar of most screens. A tall skinny one  representing a settings lock is applied. It is shown on screens that are affected by the settings lock. And the standard lock icon Padlock  which represents the Panel being locked. If both settings and panel are locked, only the panel lock will show since the settings lock doesn't do much in that situation. When the panel is locked, the Settings Screen will only show items not affected by that lock (System Info and Lock Screens).

Touch the Indicator to go to a Message Screen which shows the message.





Some messages will include the "Call for Service" text as it requires a service technician to fix the problem. If the panel is locked and a message alert appears, you will be taken to the Lock Screen (where you will need to Unlock the panel) before you can clear the message.



Touching the Error/Warning /Re-minder/Info Icon on the Message Screen will take you to the System Information Screen to allow for troubleshooting over the phone or for a field service tech to better understand what is going on. Exiting the System information Screen will take you back to the Message Screen in that situation.



  = Adjust set temperature lower



  = on  = inactive  = disabled

 **Message waiting indicator:**
The Message Waiting Indicator will show one of the following icons:



-  = fatal error (Spa can't function until it's fixed)
-  = Normal Error or Warning
-  = Reminder Message
-  = Information Message



  = Adjust set temperature higher

  = Spa equipment control icon
Brings up a screen where the spa jets, blower or other equipment can be controlled. While on the Spa Equipment Screen, you can press a Jets button once for low speed, and if configured press it again for high speed.

  = Jet is inactive. Indicates if a pump is running or not

Current water temperature if °F or °C is solid
Set temperature if °F or °C is flashing

  = Settings is active  = Settings is inactive
(when the panel is locked). Takes you to Settings Screen

  Different animation sequences, including blinking, may indicate different stages of heating

NAVIGATION

 Navigating the entire menu structure is done by touching the screen.

 The three screen selections indicated below can be selected. Touch one of these to enter a different screen with additional controls.

 Most menu screens time out and revert to the main screen after 30 seconds of no activity.

 At the bottom of the screen, at certain times an indicator may appear showing that a message is waiting. Touch this indicator to go to the Message Display Screen. On that Screen some of the messages can be dismissed. For more on the Message Display Screen, see pages 25-30.

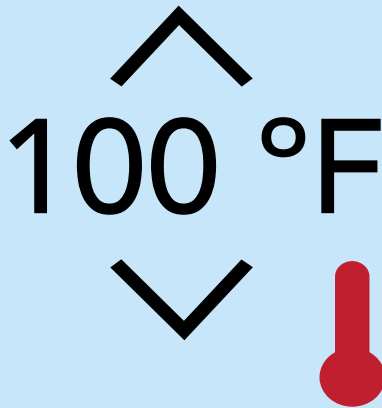

The Set Temperature

Press Up or Down once to display the Set Temperature (indicated by a flashing °F or °C, plus a change in color of the temperature). Press Up or Down again to modify the Set Temperature. The Set Temperature changes immediately.

If you need to switch between High Temperature Range and Low Temperature Range you need to go to the Settings Screen.

Press & Hold

If Up or Down is pressed and held, the temperature will continue to change until you stop pressing, or until the Temperature Range limits are reached.

The Spa Screen

All Equipment Access

The Spa Screen shows all available equipment* to control. The display shows icons that are related to the equipment installed on a particular spa model, so this screen may change depending on the installation. The icon buttons are used to select and control individual devices.

Some devices, like pumps, may have more than one ON state, so the icon will change to reflect the state of the equipment. Below are some examples of 2-speed Pump indicators.



If the Spa has a Circ Pump, a Circ Pump Icon will appear to indicate its activity, but outside of Priming Mode, the Circ Pump cannot be controlled directly.

*One exception: The Main Spa Light is not shown on the Spa Screen; it is only shown (and controlled) on the Main Screen.

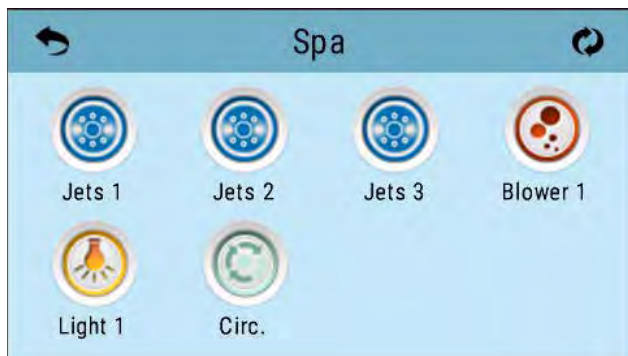

Common Buttons

If an Up or Down button is shown and pressed when on an editing page, and a value has been selected (highlighted), the value can be incremented by pressing the up arrow or decremented by pressing the down arrow.

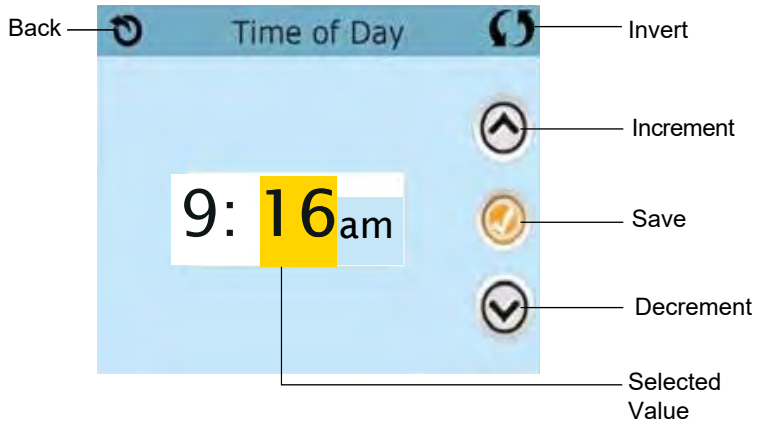

Exiting Screens

The Back button is on every screen except the Main Screen, the Priming Mode Screen and a Message Display Screen. When you see only this button, or this button plus an Inactive Save Button, it means Back or Exit. It appears on editing screens before you have changed any value, as well as on all other screens.

When you see both the Back button and an Active Save button, the Save button will Save, while the Back button will Cancel. If the screen times out due to no activity it will act like Cancel.



If there is a right arrow at the bottom of the screen, it takes you to the next page.

Page Left | Page Right

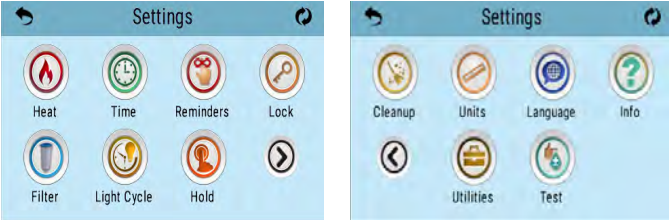

Page up | Down

If an Up or Down button is shown and pressed when on a page with a text list, the list can be scrolled a page at a time.

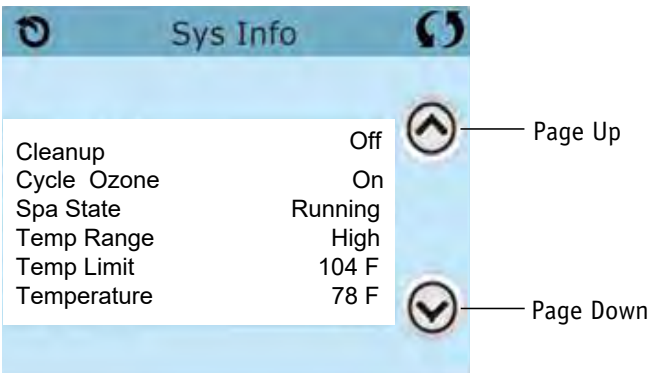

The Settings Screen

Programming, etc.

The Settings Screen is where all programming and other spa behaviors are controlled. Each icon on the Settings screen takes you to a different screen, where one or more setting may be viewed and/or edited.

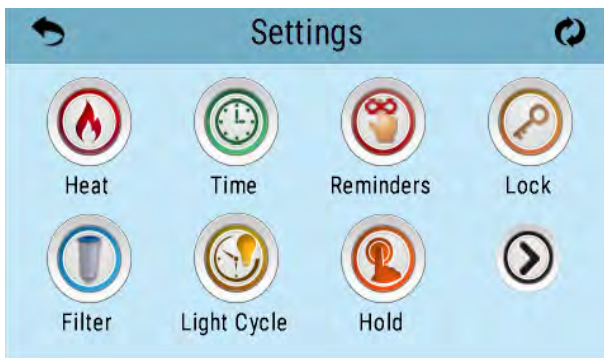

The Heat Icon  takes you to a screen where you control the Heat Mode and the Temperature Range.

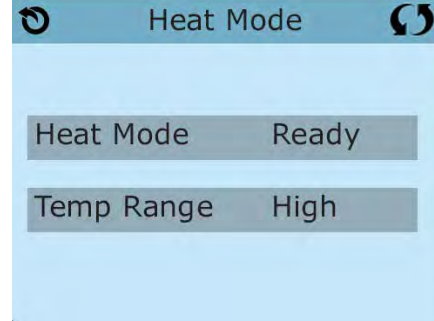

Dual Temperature Ranges

High vs. Low

This system incorporates two temperature range settings with independent set temperatures. The specific range can be selected on the Settings screen and is visible on the Main Screen in the upper left corner of the display. These ranges can be used for various reasons, with a common use being a “ready to use” setting vs. a “vacation” setting. Each range maintains its own set temperature as programmed by the user. This way, when a range is chosen, the spa will heat to the set temperature associated with that range.

- High Range can be set between 80°F and 104°F.
- Low Range can be set between 50°F and 99°F.

More specific Temp Ranges may be determined by the Manufacturer.

Freeze Protection is active in either range.

Heat Mode

Ready vs. Rest | Circulation Mode | Ready-in-Rest Mode

Heat Mode – Ready vs. Rest

In order for the spa to heat, a pump needs to circulate water through the heater. The pump that performs this function is known as the “heater pump.”

The heater pump can be either a 2-speed pump (Pump 1) or a circulation pump.

If the heater pump is a 2-Speed Pump 1, Ready Mode will circulate water every 1/2 hour, using Pump 1 Low, in order to maintain a constant water temperature, heat as needed, and refresh the temperature display. This is known as “polling.”

Rest Mode will only allow heating during programmed filter cycles. Since polling does not occur, the temperature display may not show a current temperature until the heater pump has been running for a minute or two.

When the heater pump has come on automatically (for example for heating) you can switch between low speed and high speed but you cannot turn the heater pump off.

Circulation Mode

If the spa is configured for 24HR circulation, the heater pump generally runs continuously. Since the heater pump is always running, the spa will maintain set temperature and heat as needed in Ready Mode, without polling. In Rest Mode, the spa will only heat to set temperature during programmed filter times, even though the water is being filtered constantly when in 24HR circulation mode.

Ready-in-Rest Mode

Ready in Rest Mode appears in the display if the spa is in Rest Mode and the Jets 1 Button is pressed. When the heater pump has come on automatically (for ex-ample for heating) you can switch between low speed and high speed but you cannot turn the heater pump off. After 1 hour, the System will revert to Rest Mode. This mode can also be reset by selecting the Heat Mode line on the Screen shown here.

Fill it up!

Preparation & Filling

Fill the spa to its correct operating level. Be sure to open all valves and jets in the plumbing system before filling to allow as much air as possible to escape from the plumbing and the control system during the filling process. After turning the power on at the main power panel, the top-side panel will display a splash screen or startup screen.

Priming Mode – M019*

After the initial start-up sequence, the control will enter Priming Mode and display a Priming Mode screen. Only pump icons appear on the priming mode screen. During the priming mode, the heater is disabled to allow the priming process to be completed without the possibility of energizing the heater under low-flow or no-flow conditions. Nothing comes on automatically, but the pump(s) can be energized by selecting the “Jet” buttons. If the spa has a Circ Pump, it can be turned on and off by pressing the “Circ” button during Priming Mode.

Priming the Pumps

As soon as the Priming Mode screen appears on the panel, select the “Jets 1” button once to start Pump 1 in low-speed and then again to switch to high-speed. Also, select the other pumps, to turn them on. The pumps should be running in high-speed to facilitate priming. If the pumps have not primed after 2 minutes, and water is not flowing from the jets in the spa, do not allow the pumps to continue to run. Turn off the pumps and

repeat the process.

Note: Turning the power off and back on again will initiate a new pump priming session. Sometimes momentarily turning the pump off and on will help it to prime. Do not do this more than 5 times. If the pump(s) will not prime, shut off the power to the spa and call for service.

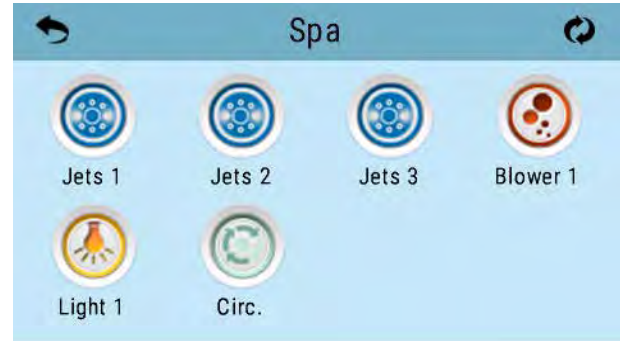

Important: A pump should not be allowed to run without priming for more than 2 minutes. Under NO circumstances should a pump be allowed to run without priming beyond the end of the 4-5 minute priming mode. Doing so may cause damage to the pump and cause the system to energize the heater and go into an overheat condition.

Exiting Priming Mode

The system will automatically enter the normal heating and filtering at the end of the priming mode, which lasts 4-5 minutes.

You can manually exit Priming Mode by pressing the “Back” button on the Priming Mode Screen. Note that if you do not manually exit the priming mode as described above, the priming mode will be automatically terminated after 4-5 minutes. Be sure that the pump(s) have been primed by this time.

— — °F — — — — °C

Once the system has exited Priming Mode, the top-side panel will display the Main Screen, but the display will not show the water temperature yet, as shown below. This is because the system requires approximately 1 minute of water flowing through the heater to determine the water temperature and display it.

**M0XX is a Message Code.*

Spa Behavior

Pumps

On the Spa Screen, select a “Jets” button once to turn the pump on or off, and to shift between low- and high-speeds if equipped. If left running, the pump will turn off after a time-out period.

Non-Circ Systems

The low-speed of pump 1 runs when the blower or any other pump is on. If the spa is in Ready Mode (See page 11), Pump 1 low may also activate for at least 1 minute every 30 minutes to detect the spa temperature (polling) and then to heat to the set temperature if needed. When the low-speed turns on automatically, it cannot be deactivated from the panel, however the high speed may be started.

Circulation Pump Modes

If the system is equipped with a circ pump, it will be configured to work in one of three different ways:

1. The circ pump operates continuously (24 hours) with the exception of turning off for 30 minutes at a time when the water temperature reaches 3°F (1.5°C) above the set temperature (most likely to happen in very hot climates).
2. The circ pump stays on continuously, regardless of water temperature.
3. A programmable circ pump will come on when the system is checking temperature (polling), during filter cycles, during freeze conditions, or when another pump is on. The specific Circulation Mode that is used has been determined by the Manufacturer and cannot be changed in the field.

Other device options may be available, like Blower, Light, Mister, etc.

Filtration and Ozone

On non-circ systems, Pump 1 low and the ozone generator will run during filtration. On circ systems, the ozone will generally run with the circ pump, but can be limited to filtration cycles. (On some circs systems, Pump 1 low will run along with the circ Pump during filtration.)

The system is factory-programmed with one filter cycle that will run in the evening (assuming the time-of-day is properly set) when energy rates are often lower. The filter time and duration are programmable. A second filter cycle can be enabled as needed.

At the start of each filter cycle, the water devices like blower, mister device (if these exist) and other pumps will run briefly to purge the plumbing to maintain good water quality.

Freeze Protection

If the temperature sensors within the heater detect a low enough temperature, then the water devices automatically activate to provide freeze protection. The water devices will run either continuously or periodically depending on conditions.

In colder climates, an optional freeze sensor may be added to protect against freeze conditions that may not be sensed by the standard sensors. Auxiliary freeze sensor protection acts similarly except with the temperature thresholds determined by the switch. See your dealer for details.

Clean-up Cycle (optional)

When a pump or blower is turned on by a button press, a clean-up cycle begins 30 minutes after the pump or blower is turned off or times out. The pump and the ozone generator will run for 30 minutes or more, depending on the system. On some systems, you can change this setting.

Time of Day

Be sure to set the Time-of-Day

Setting the time-of-day is important for determining filtration times and other background features.

The Heat Icon  on the Settings Screen takes you to a screen where you control the Time-of-Day.

On the Time-of-Day screen, simply select the Hours and Minutes. Use the Up and Down Buttons to make changes, then Save.

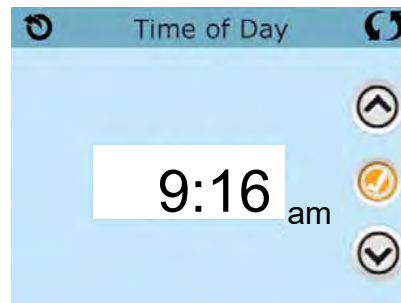

If no Time-of-Day is set...

In the memory an Information Screen will appear. If you exit it and Information Icon will appear at the bottom of the Main Screen, until the time-of-day has been set.

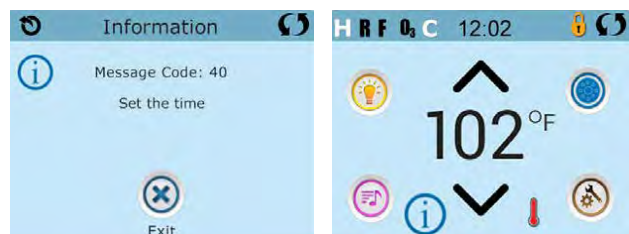

NOTE:

This only applies to some systems:

If power is interrupted to the system, Time-of-Day will be maintained for several days.

Adjusting Filtration

Main Filtration

Using the same adjustment as Setting the Time, Filter Cycles are set using a start time and a duration. Each setting can be adjusted in 15-minute increments. The panel calculates the end time and displays it automatically.

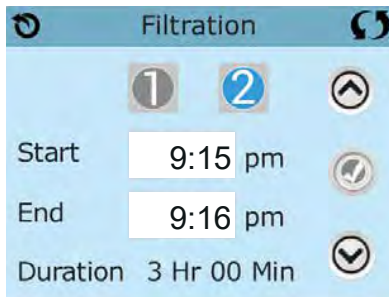

Filter Cycle 2 - Optional Filtration

Filter Cycle 2 is OFF by default.



Viewing Filter 1 while Filter 2 is OFF Viewing Filter 1 while Filter 2 is ON

Press "1" to view Filter 1. Press "2" once to view Filter 2. Press "2" again to turn Filter 2 ON or OFF.

When Filter Cycle 2 is ON, it can be adjusted in the same manner as Filter Cycle 1.

It is possible to overlap Filter Cycle 1 and Filter Cycle 2, which will shorten overall filtration by the overlap amount.

Circulation Pump Modes

Some spas may be manufactured with Circ Pump settings that allow programming filtration cycle duration. Some circ Modes are pre-programmed to operate 24 hours a day and are not programmable. Refer to the spa manufacturer's documentation for any Circ Mode details.

Purge Cycles

In order to maintain sanitary conditions, as well as protect against freezing, secondary water devices will purge water from their respective plumbing by running briefly at the beginning of each filter cycle.

(Some systems will run a certain number of purge cycles per day, independent of the number of filter cycles per day. In this case, the purge cycles may not coincide with the start of the filter cycle).

If the Filter Cycle 1 duration is set for 24 hours, enabling Filter Cycle 2 will initiate a purge when Filter Cycle 2 is programmed to begin.

The Meaning of Filter Cycles

1. The heating pump always runs during the filter cycle*
2. In Rest Mode, heating only occurs during the filter cycle
3. Purges happen at the start of each filter cycle

* For example, if your spa is set up for 24/hour circulation except for shutting off when the water temperature is 3°F/1.3°C above the set temperature, that shutoff does not occur during filter cycles.

Additional Settings

Light Cycle Option

If Light Cycle does not appear on the Settings Screen, the Light Timer feature is not enabled by the manufacturer. The Light Cycle Icon on the Settings Screen takes you to a screen where you control the Light Cycle. When available, the Light Timer is ("Disabled") by default. Press "Disabled" to change it to "Enabled" (ON). The settings can be edited the same way that Filter Cycles are edited.

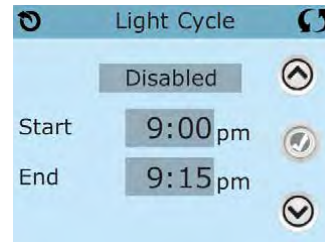

Auxiliary Panel(s)

Specific Buttons for Specific Devices

If the spa has an Auxiliary Panel(s) installed, pressing buttons on that panel will activate the device indicated for that button. These dedicated buttons will operate just like the Spa Screen buttons (see page 6) and the equipment will behave in the same manner with each button press.

Restricting Operation

The control can be restricted to prevent unwanted use or temperature adjustments. Locking the Panel prevents the controller from being used, but all automatic functions are still active. Locking the Settings allows Jets and other features to be used, but the Set Temperature and other programmed settings cannot be adjusted. Settings Lock allows access to a reduced selection of menu items. These include Filter Cycles, Invert, Information and Fault Log. They can be seen, but not changed or edited.

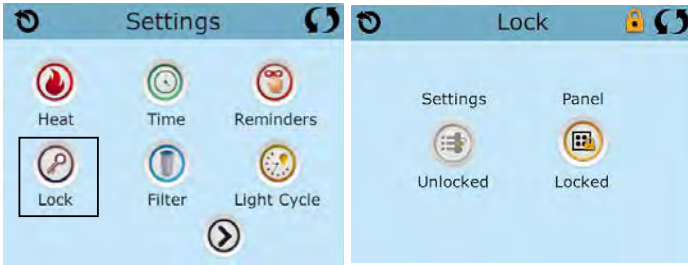

Panel Locked and Settings Unlocked

Locking/Unlocking

The same steps are used to Lock and Unlock. To lock either Settings or Panel first select Settings (if it says "Unlocked") or Panel (if it says "Unlocked"), then press the word "Lock" for at least 5 seconds. To unlock either Settings or Panel first select Settings (if it says "Locked") or Panel (if it says "Locked"), then press the word "Lock" for at least 5 seconds.

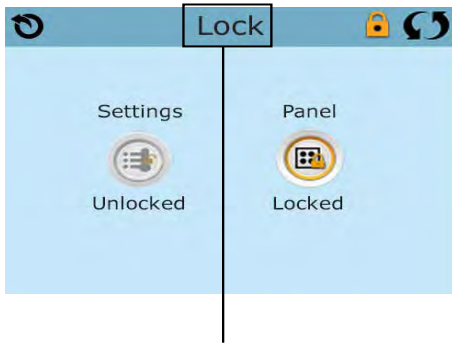

Press here for 5 seconds to lock or unlock

Hold - M037*

Hold Mode is used to disable the pumps during service functions like cleaning or replacing the filter. Hold Mode will last for 1 hour unless the mode is exited manually. If spa service will require more than an hour, it may be best to simply shut down power to the spa.

The Hold Icon on the Settings Screen places the spa in Hold Mode and displays the System Hold screen. Touch Back to exit Hold Mode.

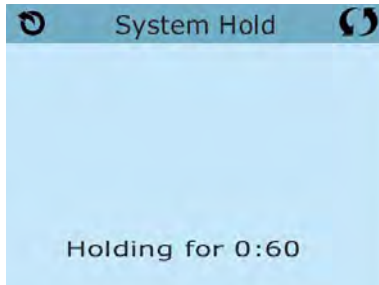

Drain Mode

Some spas have a special feature that allows Pump 1 to be employed when draining the water. When available, this feature is a component of Hold Mode.

*M0XX is a Message Code.

Codes like this will be seen in the Fault Log

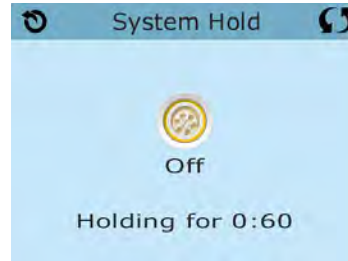

Utilities Screen

Utilities

The Utilities Icon on the Settings Screen takes you to the Utilities Screen. The Utilities Screen contains the following:

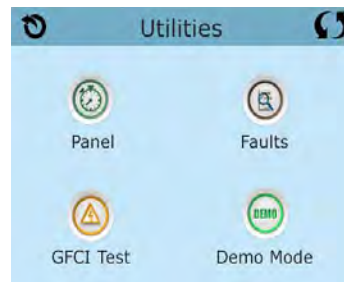

Panel

Touching the Panel Icon on the Utilities Screen takes you to the Panel Screen, where you can set how long it takes the panel to go to sleep after the last activity. The Sleep Timer can be set from 1 minute to 60 minutes. The default is 30 minutes.

Demo Mode

Demo Mode is not always enabled, so it may not appear. This is designed to operate several devices in a sequence in order to demonstrate the various features of a particular hot tub.

Fault Log

The Fault Log is a record of the last 24 faults that can be reviewed by a service tech. Use the Up and Down buttons to view each of the Faults. When Priming Mode shows in the Fault Log, it is not a fault. Rather, it is used to keep track of spa restarts.

GFCI Test

(Feature not available on CE rated systems.)

Your systems may have GFCI configured in one of three ways:

1. GFCI test is not enabled.
2. Manual GFCI test is enabled but automatic GFCI test is not enabled.
3. Both manual and automatic GFCI tests are enabled. The automatic test will happen within 7 days of the spa being installed and if successful will not repeat. (If the automatic test fails it will repeat after the spa is restarted.) GFCI Test will not appear on the screen if it is not enabled. This screen allows the GFCI to be tested manually from the panel and can be used to reset the automatic test feature.

GFCI Test will not appear on the screen if it is not enabled. This screen allows the GFCI to be tested manually from the panel and can be used to reset the automatic test feature.

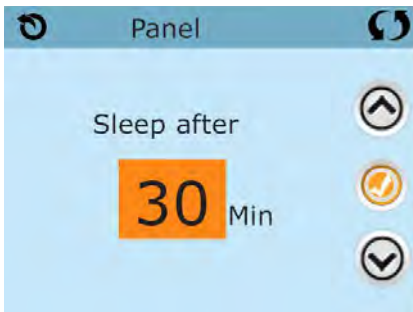

Units Screen

The Units Icon on the Settings Screen takes you to the Units Screen.

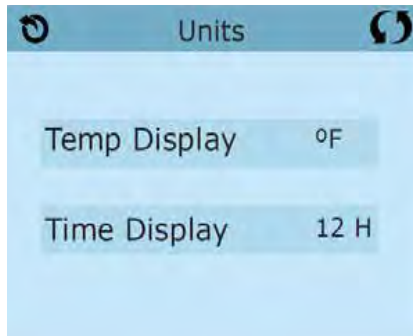

1. Press "Temp Display" to change the temperature between Fahrenheit and Celsius.
2. Press "Time Display" to change the clock between 12 hr and 24 hr display.

Reminders

The Reminder Icon on the Settings Screen takes you to the Reminders screen.

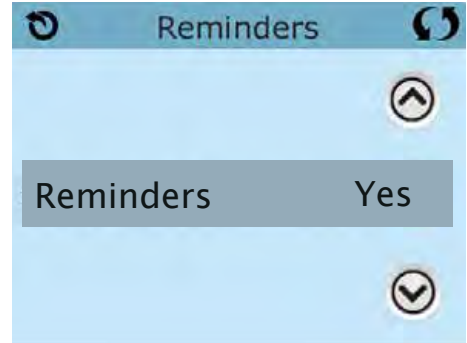

Press "Reminders" to turn the reminder messages (like "Clean Filter") ON (Yes) or OFF (No).

Cleanup Cycle

Cleanup Cycle Duration is not always enabled, so it may not appear. When it is available, set the length of time Pump 1 will run after each use. 0-4 hours are available. Settings it to 0.0 Hr keeps the Cleanup Cycles from running.

The Cleanup Icon on the Settings Screen takes you to the Cleanup Cycle screen.

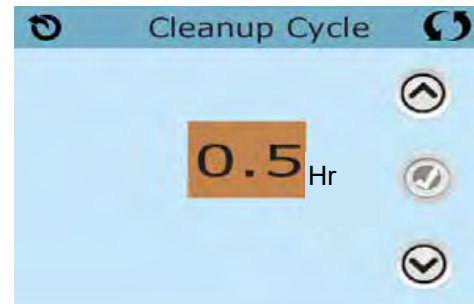

Cleanup Cycle

The Language Icon on the Settings Screen takes you to the Language screen. Change the language displayed on the panel.

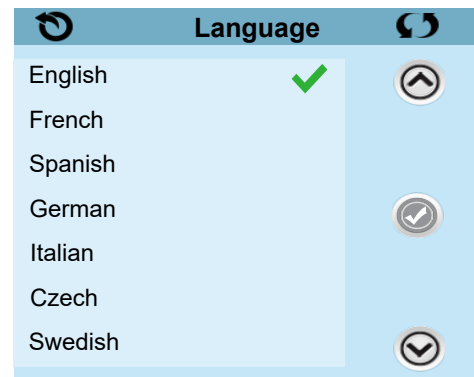

Utilities

GFCI Test Feature

The Ground Fault Circuit Interrupter (GFCI) or Residual Current Detector(RCD) is an important safety device and is required equipment on a hot tub installation.

(The GFCI Test Feature is not available on CE rated systems).

Used for verifying a proper installation

Your spa may be equipped with a GFCI Protection feature. If your spa has this feature enabled by the manufacturer, the GFCI Trip Test must occur to allow proper spa function.

On some systems:

Within 1 to 7 days after startup, the spa will trip the GFCI to test it. (The number of days is factory programmed.) The GFCI must be reset once it has tripped. After passing the GFCI Trip Test, any subsequent GFCI trips will indicate a ground fault or other unsafe condition and the power to the spa must be shut off until a service person can correct the problem.

Forcing the GFCI Trip Test (North America Only)

 Touching the GFCI Test Icon on the Utilities Screen takes you to the GFCI Test screen.

The installer can cause the GFCI Trip Test to occur sooner by pressing Test on the GFCI Test screen.

The GFCI should trip within several seconds and the spa should shut down. If it does not, shut down the power and manually verify that a GFCI breaker is installed and that the circuit and spa are wired correctly. Verify the function of the GFCI with its own test button. Restore power to the spa and repeat the GFCI Trip Test.

Once the GFCI is tripped by the test, reset the GFCI and the spa will operate normally from that point. You can verify a successful test by navigating to the above screen. "Passed" should appear after the Reset line is selected on the GFCI screen.

Warning:

On those systems that automatically test the GFCI within 1 to 7 days after startup:

The end-user must be trained to expect this one-time test to occur. The end-user must be trained how to properly reset the GFCI. If freezing conditions exist, the GFCI or RCD should be reset immediately or spa damage could result.



CE Product

CE registered systems do not have an RCD Test Feature due to the nature of the electrical service. Some UL registered systems do not have the GFCI Test Feature activated. The end-user must be trained how to properly test and reset the RCD.

Reset Button:

Only use the Reset Button prior to moving the spa to a new location. Pressing the Reset the button forces a new Test to be performed at the new location.

General Messages

Most messages and alerts will appear at the bottom of the normally used screens. Several alerts and messages may be displayed in a sequence.

---°F ---°

Water Temperature is Unknown

After the pump has been running for 1 minute, the temperature will be displayed.

Possible freezing condition

A potential freeze condition has been detected, or the Aux Freeze Switch has closed. All water devices are activated. In some cases, pumps may turn on and off and the heater may operate during Freeze Protection. This is an operational message, not an error indication.

The water is too hot – M029*

The system has detected a spa water temp of 110°F (43.3°C) or more, and spa functions are disabled. System will auto reset when the spa water temp is below 108°F (42.2°C). Check for extended pump operation or high ambient temp.

The water level is too low

This message can only appear on a system that uses a water level sensor. It appears whenever the water level get too low (or the water level sensor is disconnected), and automatically disappears when the water level is adequate. Pumps and the heater turn OFF when this message appears.



Heater-Related Messages

The water flow is low – M016**

There may not be enough water flow through the heater to carry the heat away from the heating element. Heater start up will begin again after about 1 min. See “Flow Re-lated Checks” below.

The water flow has failed* – M017**

There is not enough water flow through the heater to car-ry the heat away from the heating element and the heater has been disabled. See “Flow Related Checks” below. After the problem has been resolved, reset the message*.

The heater may be dry* – M028**

Possible dry heater, or not enough water in the heater to start it. The spa is shut down for 15 min. Reset this message* to reset the heater start-up. See “Flow Related Checks” below.

The heater is dry* – M027**

There is not enough water in the heater to start it. The spa is shut down. After the problem has been resolved, you must reset the message* to restart heater start up. See “Flow Related Checks” below.

The heater is too hot* – M030**

One of the water temp sensors has detected 118°F (47.8°C) in the heater and the spa is shut down. You must reset the message* when water is below 108°F (42.2°C). See “Flow Related Checks” below.

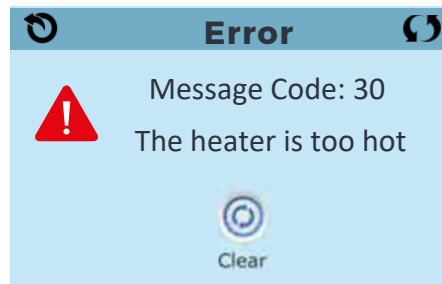

Flow-related checks

Check for low water level, suction flow restrictions, closed valves, trapped air, too many closed jets and pump prime. On some systems, even when spa is shut down by an error condition, some equipment may occasionally turn on to continue monitoring temperature or if freeze protection is needed.

* **Some messages can be reset from the panel.** Messages that can be reset will appear with a Clear Icon at the bottom of the Message Screen. Press the Clear Icon text to reset the message.

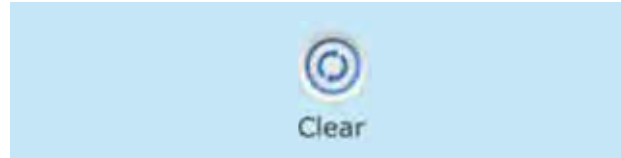

**M0XX is a Message Code.

Codes like this will be seen in the Fault Log

Sensor-Related Messages

Sensors are out of sync – M015**

The temperature sensors MAY be out of sync by 3°F. Call for Service if this message does not disappear within a few minutes.

Sensors are out of sync -- Call for service* – M026**

The temperature sensors ARE out of sync. The fault above has been established for at least 1 hour. Call for Service.

Sensor A Fault, Sensor B Fault – Sensor A: M031**, Sensor B M032**

A temperature sensor or sensor circuit has failed. Call for Service.

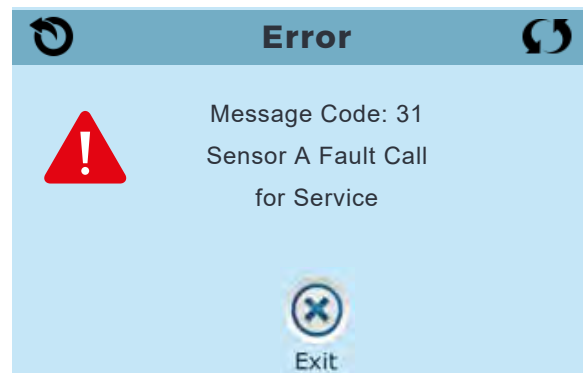

Miscellaneous Messages

Communications error

The control panel is not receiving communication from the System. Call for Service.

Test software installed

The Control System is operating with test software. Call for Service.

* Some messages can be reset from the panel.

Messages that can be reset will appear with a Clear Icon at the bottom of the Message Screen. Press the Clear Icon text to reset the message.



**M0XX is a Message Code.

Codes like this will be seen in the Fault Log

Reminder Messages

General maintenance helps

Reminder Messages can be suppressed by using the Reminders Screen. Reminder Messages can be chosen individually by the Manufacturer. They may be disabled entirely, or there may be a limited number of reminders on a specific model. The frequency of each reminder (i.e. 7 days) can be specified by the Manufacturer.

Check the pH

May appear on a regular schedule, i.e. every 7 days. Check pH with a test kit and adjust pH with the appropriate chemicals.

Check the sanitizer

May appear on a regular schedule, i.e. every 7 days. Check sanitizer level and other water chemistry with a test kit and adjust with the appropriate chemicals.

Clean the filter

May appear on a regular schedule, i.e. every 30 days. Clean the filter media as instructed by the manufacturer.

Test the GFCI (or RCD)

May appear on a regular schedule, i.e. every 30 days. The GFCI or RCD is an important safety device and must be tested on a regular basis to verify its reliability. Every user should be trained to safely test the GFCI or RCD associated with the hot tub installation. A GFCI or RCD will have a TEST and RESET button on it that allows a user to verify proper function.

Change the water

May appear on a regular schedule, i.e. every 90 days. Change the water in the spa on regular basis to maintain proper chemical balance and sanitary conditions.

Clean the cover

May appear on a regular schedule, i.e. every 180 days. Covers should be cleaned and conditioned for maximum life.

Treat the wood

May appear on a regular schedule, i.e. every 180 days. Wood skirting and furniture should be cleaned and conditioned per the manufacturer's instructions for maximum life.

Change the filter

May appear on a regular schedule, i.e. every 365 days. Filters should be replaced occasionally to maintain proper spa function and sanitary conditions.

Change the UV

May appear on a regular schedule. Change the UV as instructed by the manufacturer.

Check ozone

May appear on a regular schedule. Change the UV as instructed by the manufacturer.

Service check-up

May appear on a regular schedule. Do a service check-up as instructed by the manufacturer.

Additional messages may appear on specific systems. Reminder messages can be reset from the panel. Messages that can be reset will appear with a Clear Icon at the bottom of the Message Screen. Press the Clear Icon text to reset the message.



Warning! Qualified Technician Required for Service and Installation.

BALBOA WI-FI MODULE

With the Balboa Wi-Fi Module installed in your spa follow the steps below to setup/configure the device.

Step 1: Download the app from the Google Play store or the iTunes store. The app will be titled “Coast Spas—Spa Remote” (Google) or Coast Spas—Remote Spa Control (iTunes).

Step 2: Make sure your Wi-Fi on your device is enabled. Check your device’s instructions on how to access Wi-Fi Settings.

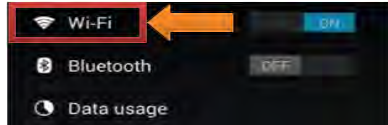

Step 3: While standing at the spa select the Wi-Fi Module from the list of available devices from your device’s Wi-Fi menu. The Wi-Fi device will appear as BWGSpa_XXXXX in the list.

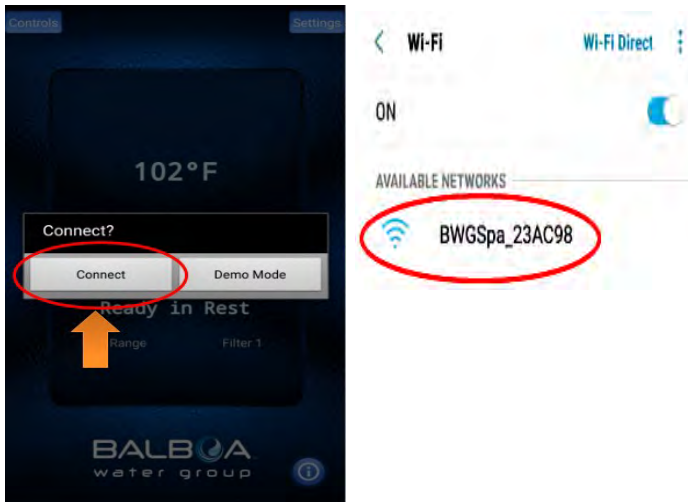

Step 4: Once connected to the Wi-Fi Module directly open the Coast Spas app. The Coast Spas app will allow you to control and interact with the spa while you are still with in range.



Selecting “Controls” will open a list of installed components like pump(s), blower, lights, etc.

Note: This screen will vary depending on installed components.

Selecting “Settings” will open the settings menu. While connected to the spa will be able to set the temperature, change the degrees between °F or °C, alter the heat mode (Ready/Rest), select the temperature range (low or high), set the time of day, input filter cycles (time start and duration) and have access to the advanced menu.

For more information on the various settings please refer to the selection in the owner’s manual for your topside control.

Connecting to the Home Network

Note: You can only connect the Wi-Fi app to the house network when connected directly to the Wi-Fi Module. See “Getting Started” to connect directly to the Wi-Fi Module.

Once connected to the Wi-Fi Module navigate to:

Settings ► Advanced ► Wi-Fi Settings



Step 5: Select your routers security setting. This will vary and if the wrong setting is selected the app will not be able to access the spa.

Step 6: Set your home network. Each router will have its own unique SSID (Service Set Identifier).

Step 7: Enter your key. The key will be the passkey used to sign in on your network.

Note: If you do not know or need assistance locating any of the information above please contact your locale service provider.

CONTROLMYSPA™ (LUXURY MODELS ONLY)

CMS™ SYSTEM CONSISTS OF:



WEBSITE

ControlMySpa™ website with Login and access to spas

CMS™ GATEWAY ULTRA Modules



Home Module



Spa Module

www.balboawater.com/GatewayUltra

SMARTPHONE | TABLET



iOS (Apple) ControlMySpa™ mobile app and/or Android ControlMySpa™ Mobile app

The ControlMySpa™ system consists of:

- ControlMySpa™ GATEWAY ULTRA installed on a spa/Hot Tub
- iOS (Apple) ControlMySpa™ mobile app or Android ControlMySpa™ mobile app
- ControlMySpa™ website with log-in and access to spas

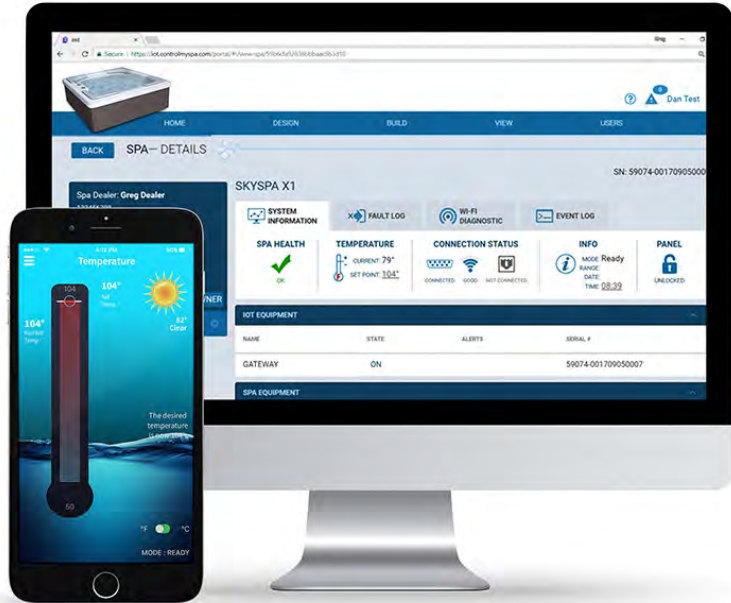

The ControlMySpa™ Logins:

- The iOS or Android ControlMySpa™ apps can only be accessed with an owner log-in
- The ControlMySpa™ website can be accessed with an owner log-in.

ControlMySpa™ App for the smart device

FOR IPHONE® OR IPAD® (IOS/APPLE)

Search the Apple iOS App Store for “controlmyspa” Or

Use this link: <https://goo.gl/j31t1V>



FOR ANDROID® PHONES/TABLETS

Search Google Play App Store for “controlmyspa”

Or Use this link: <https://goo.gl/CG4Yci>



ControlMySpa™

Connect GATEWAY ULTRA hardware in your home

Step 1

Plug the supplied ethernet cable into the home router (A).

Step 2

Plug the other end of the ethernet cable into the GATEWAY ULTRA module (B).

Step 3

Plug the supplied power cord into the GATEWAY ULTRA module (C).

Step 4

Plug the other end of the supplied power cord into wall power (D).



GATEWAY ULTRA Module (side view)

LED Light Chart (E)

This chart applies to the home and spa GATEWAY ULTRA modules.

- Red - Solid: The GATEWAY ULTRA and the spa are not connected.
- Red - Blinking: Home and spa GATEWAY ULTRA modules are connected, but no connection to the spa controller.
- Blue - Blinking: Remote software update is underway. Do not unplug power.
- Green - Blinking: CMS™ GATEWAY ULTRA spa and home modules RF is connected, but no connection to internet.
- Green - Solid: Spa successfully connected to internet. No errors.

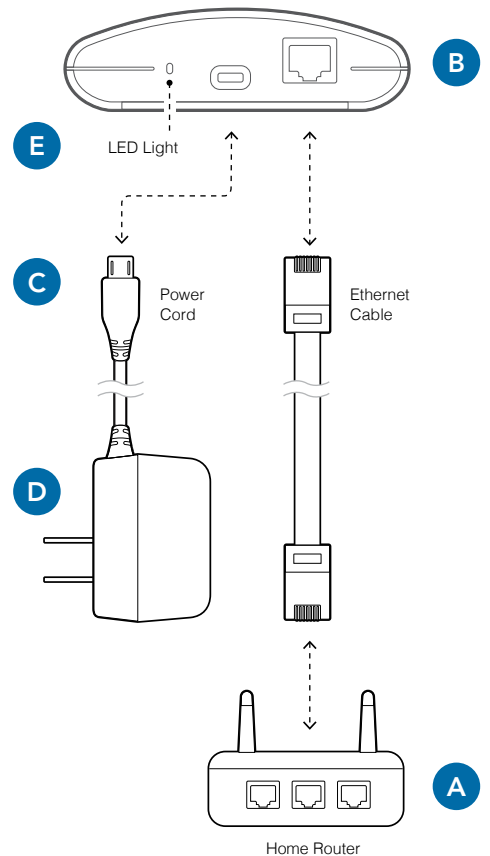

CMS™ Code Overview

WHAT IS A CMS™ CODE?

- CMS™ Code is an 8 digit letter/number combination that all Spa owners must have to use spas equipped with the ControlMySpa™ system
 - A) The CMS™ code is obtained from your Dealer.
- Spa owners will need this CMS™ code to setup and connect their spas in the ControlMySpa™ database.
- The CMS™ code connects your spa to your OEM and Dealer for service and support

EXAMPLE CMS™ Code: ABC-12345

ABC = 3 letter code unique to each spa Manufacturer or OEM
12345 = 5 number code unique to each spa Dealer or Distributor.

ControlMySpa™

Setup Spa Owner User Account



- 1. Open the app on your smart device**
Press "SETUP" on the app.



- 2. Press "Next"** Confirm Bluetooth is ON in the iOS Settings.

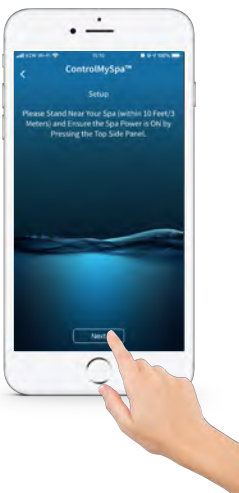

- 3. Press "Next"**
Stand near your spa (within 10 feet/3 meters) and ensure the spa power is ON by pressing the topside panel. If the spa is powered ON, press "Next".



- 4. Detect Bluetooth**



5. Press "Yes"
 The serial number in the app should match the serial number on the back of the spa module.

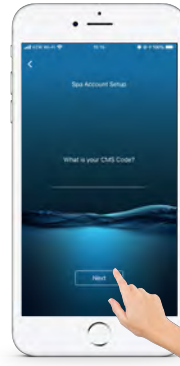

6. Press "Next"
 The CMS code is provided by your Dealer. Press "Next".



7. Press "Next"
 Input information and press "Next".



8. Press "Next"
 Input information and press "Next".

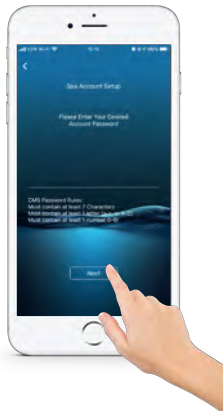

9. Press "Next"
 Input information and press "Next".



10. Press "Next"
 Your UserID and password will appear. Press "Next".

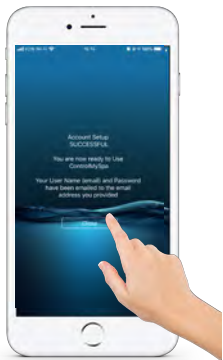

11. Press "Close"



12. Press "SIGN IN"
 Input your email address, password and press "SIGN IN".

SUCCESS! YOUR ACCOUNT IS SETUP, AND YOU CAN CONTROL YOUR SPA WITH THE CMS APP.

BALBOA BLUETOOTH AUDIO



bba3 Amplifier



Control System

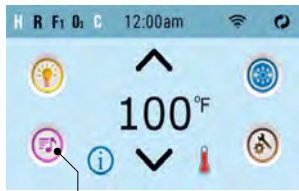

Music B



Power Button

Pairing Smart Device

- Power up the system pack with bba2 already connected to the system pack.
- On the control panel press the music button. Next, press the power button.
- Turn on Bluetooth function of your smart device or music device.
- On your smart device or music device, click search for Bluetooth device. Make sure you are close enough to the spa tub.
- On your smart device, select "BBA Spa Music" from the pairing list. If "BBA Spa Music" does not appear, repeat steps previous steps.
- Some smart devices will connect automatically and others you will need to select "Connect." Once connected, this icon will appear. Play music on your smart device. If the music plays from the speakers in the spa, the connection is complete.

NOTE: bba3 operates up to 100 feet in open air. Ranges vary as they are dependent on installations.

Bluetooth Screen

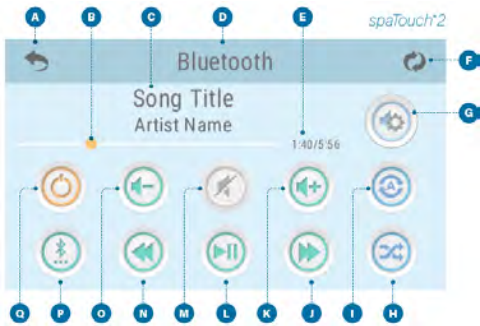

- | | |
|-----------------------------------|-------------------------------------|
| A - Back | J - Track Forward |
| B - Progress Bar | K - Volume Up |
| C - Song Title, Artist | L - Play/Pause |
| D - Screen Title: Bluetooth | M - Mute |
| E - Song Progress | N - Track Back |
| F - Invert Display | O - Volume Down |
| G - Settings | P - Input Modes: Bluetooth, Line in |
| H - Shuffle | Q - Power |
| I - Repeat: one song or all songs | |

Adjust Settings

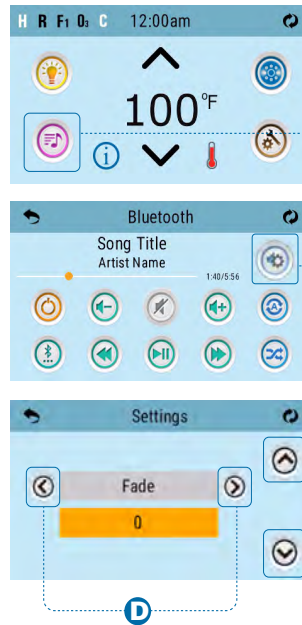

1. Follow these steps to adjust the audio settings. Press the Music button (A) to enter the Bluetooth screen.
2. Press the Settings button (B) to enter the Settings screen.
3. Press these buttons (D) to select an audio setting. The audio settings are listed below.
4. Press these buttons (C) to change the setting's value.

SETTINGS

- Balance
- Fade
- EQ Preset
- Filter
- Bass Gain

There are two types of filters: Low Pass and High Pass. These filters apply to the rear speaker output only. Select Low Pass for subwoofers or High Pass for tweeters. Select OFF if filtering is not desired. Normal speakers do not require filtering.

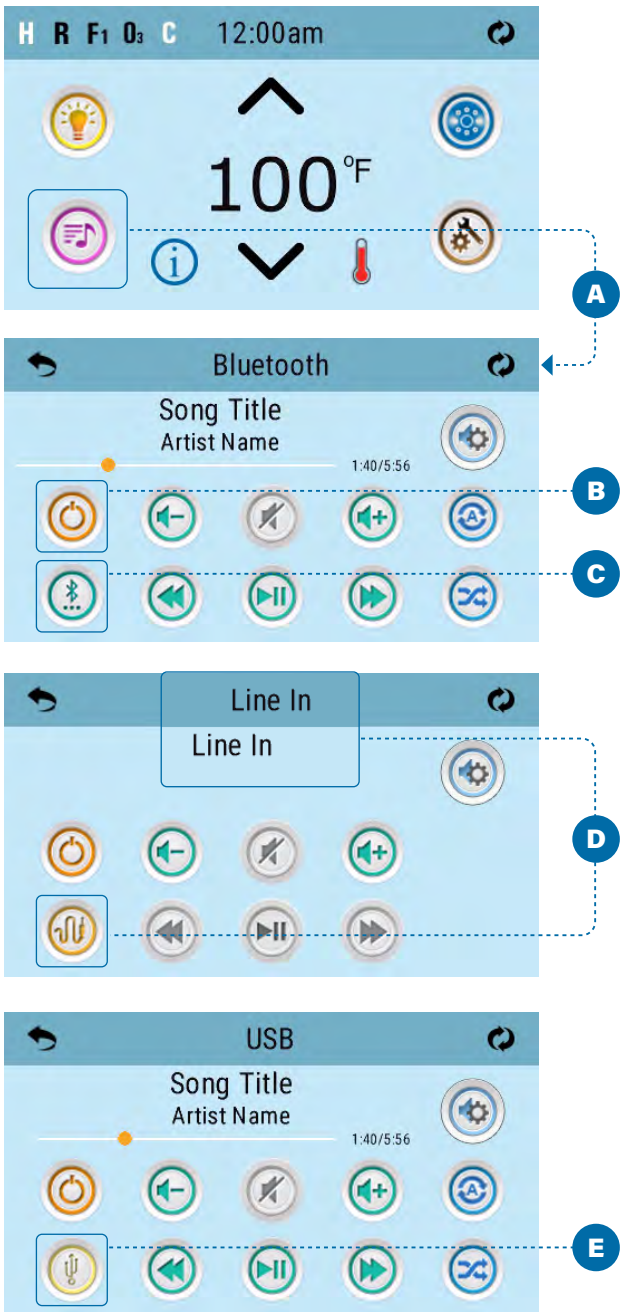

SELECT INPUT MODE

The following input modes are available: Bluetooth, Line In. All control systems are equipped with Bluetooth mode. However, control systems may or may not have Line In, as this input mode is optional.

Follow these steps to select the input mode of the bba™3 amplifier.

1. Press the Music button (A) to enter the Bluetooth screen.
2. Confirm that the bba™3 amplifier is turned On. If it is turned Off, the button icon (B) will be gray.
3. Press the Input button (C) to select one of the following input modes:

Bluetooth (C).

Line In (D)

USB (E) - USB is not available with the bba™3 amplifier, even though the icon may appear on the panel.

Line In mode (D) allows you to connect any headphone output to the Aux In connectors (F), but you will likely need an adapter cable because of the different connectors.

Only audio settings such as Volume are available when using Aux In (F).

The terms “Line In” (D) and “Aux In” (F) refer to the same thing.

INPUT MODE ICONS

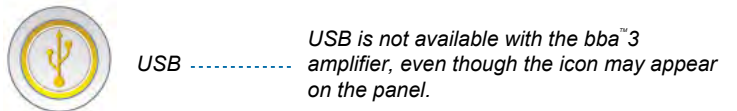

bba™3 Amplifier

TROUBLESHOOTING

Scenario 01

Problem: The error message “BT Comm Lost” (A) appears on the panel display.

Solution: The control system has lost communication with the bba™3 amplifier (B). Contact customer support for help.

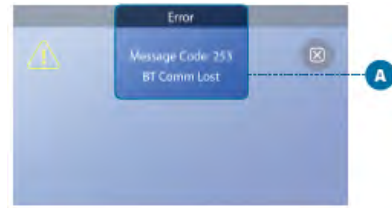

Scenario 02

Problem: When you try to connect your music device to Aux In on the bba™ amplifier, the Aux In connectors on your bba™ amplifier are different than these (C).

Solution: Your spa is equipped with an earlier version of bba™ (1 or 2). Contact customer support for help.



Scenario 03

Problem: Song title appears only sometimes or never.

Solution 1: A few music player apps never send song title and other info over Bluetooth, so try another app. Also, some music player apps don't send song title if playing automatically in the background, only if the app is “visibly running” on the device, so try “opening” the app which is playing in the background.

Solution 2: If the song title never appears, this can happen for a couple of other reasons. One, you may have an older bba™ amplifier. Two, you may have an older panel. Contact customer support for help.

Scenario 04

Problem: When you press the music button (A) or select A/V, it does not go to the Bluetooth screen.

Solution: If the screen it takes you to has a Bluetooth button (B), select that Bluetooth button to continue.

That Bluetooth button (B) may not appear if the control system (E) did not detect the bba™3 amplifier (D).

NOTE: This can appear on multiple panels. The spaTouch™2 screens on this page are used to illustrate the scenario.

Scenario 05

Problem: The Shuffle and Repeat buttons do not work on my panel.

Reason: Some music players/devices do not support Shuffle and/or Repeat.

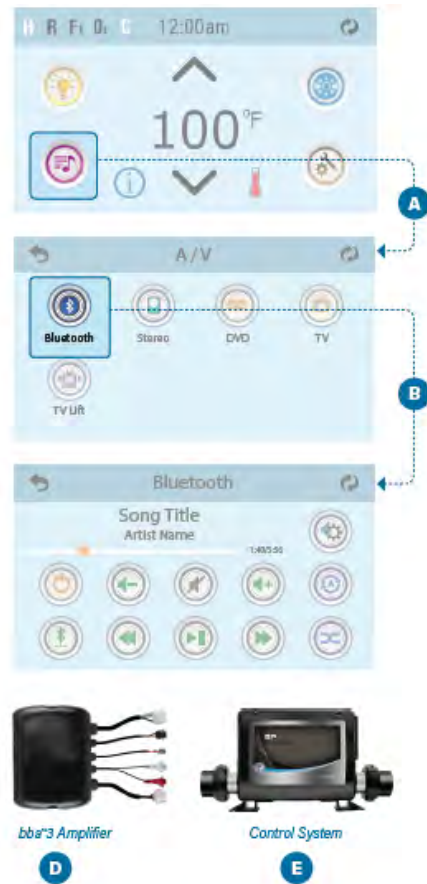

COAST STATUS



Compatible with BP Spa Packs:

North American (NA) Packs: 56689-03 and 56683-05

European (EU) Packs: 56688-04 and 56690-03

Coast Status is designed to give real time status of the spa. LED's will be tied to a cabinet mounted light fitting that the spa owner can use to tell, at a glance, if all is OK with the spa or if something requires their attention. Coast Status Warning messages shown below.

Coast Status Lighting Legends

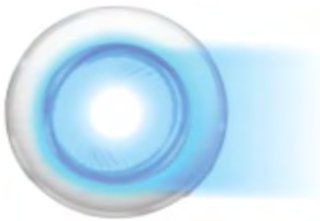

Steady Blue Light

Spa pack is operational. There are no messages, faults or error codes.



Flashing Blue Light

Spa pack is operational. There is a reminder and/or message. There is no fault. *Example: Message code 40 - this code requests you to set the time.*

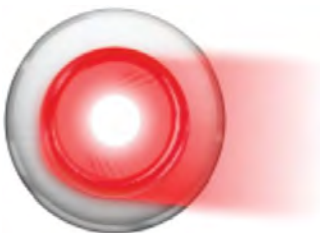

Steady Red Light

There are warning messages or faults present.



Flashing Red Light

Severe warnings or faults present.

To check message on the Control Panel screen, tap on  icon.

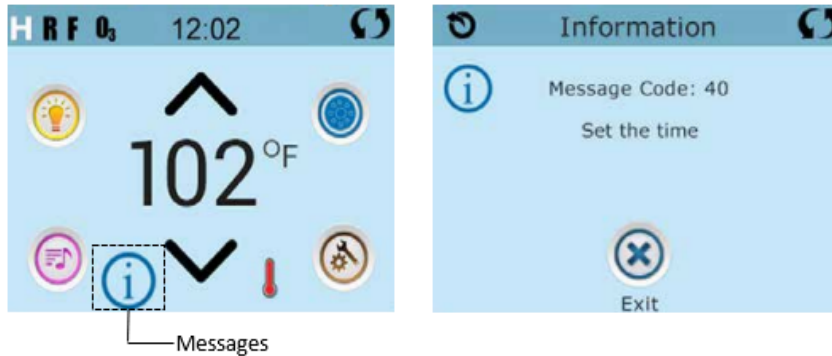

COAST STATUS MESSAGES

Message #	Message Text	Message #	Message Text	Message #	Message Text
0	<none>	20	The clock has failed	36	The GFCI test failed
1	Possible freezing condition	21	The settings have been reset	37	Hold (aka Standby) Mode
2	Test the GFCI	22	Program memory failure	38	Run Jets 1 to get temperature
3	Change the filter	23	Configuration error (Call for service)	39	Test software installed
4	Clean the filter	24	Darin Mode	40	Set the time
5	Treat the wood	25	Demo Mode	43	Change UV
6	Clean the cover	26	Sensors are out of sync (Call for service)	44	J29
7	Change the mineral cartridge	27	The heater is dry	45	The water level is too low
8	Change the water	28	The heater may be dry	47	Check Ozone
9	Check the sanitizer	29	The water is too hot	48	Service Check-Up
10	Check the pH	30	The heater is too hot	49	Check the filter now
15	Sensors are out of sync	31	Sensor A fault (Call for service)	248	Chromazon Fault: Too Many Lights
16	The water flow is low	32	Sensor B fault (Call for service)	250	Chromazon Fault: Not Responding
17	The water flow has failed	34	A pump may be stuck on	253*	BT Failure
19	Priming Mode	35	Hot fault (Call for service)	254*	Communications error (Call for service)

COAST SPAS ECOCLEAN UV STERILIZER



HOW IT WORKS

- Ultraviolet germicidal UV lamps are low pressure mercury vapor lamps which produce the UV-C dose necessary for microorganism's eradication.
- This dose (mJ/cm²) is the result of a design taking care of the flow rate, the water transmittance, reactor size and exposure time.
- Ultraviolet light is generated by an electrical discharge through low pressure inert gases and mercury vapor with the special quartz tube of the lamp.
- UV Rays generated at 254 Nm are germicidal at the optimal wavelength for eradicating micro-organisms
- Eradicates organisms that can actually live in a chlorinated environment.
- Your EcoClean UV Sterilizer imparts nothing into the water, making it an eco-friendly, reliable and effective choice.
- The sterilizers UV Bulb should be replaced and its protective quartz tube cleaned every 18 months.
- The UV-C rays of our sterilizer take care of in-line sanitation however, weekly shocking of the water is advisable to oxidize any chloramines or contaminants. An ozonator is also recommended as an excellent complimentary device for oxidation.

EASY MAINTENANCE

- Your NEW Coast Spas EcoClean UV Sterilizer is installed out of sight, concealed by your spa skirt. Quick access is gained through simply removing one skirt panel.
- Replacement of the UV lamp: Every 13 000 operating hours
- Clean quartz tube at time of lamp replacement (12 to 18 months)

QUICK FACTS

- The unique quartz tube of the EcoClean UV Sterilizer blocks out all but UV-C 254 Nm rays. Any less and a sterilizer is less effective for spas. Similarly, if a sterilizer exceeds this intensity, it will break down chlorine or bromine and be less effective as a result.
- Although you should keep your spa water balanced, balancing chemicals do not alter the effectiveness of the sterilizer, as it neutralizes 99.9% of viruses and bacteria.
- Because the EcoClean UV Sterilizer is eliminating chloramines and organisms in-line, the free chlorine or bromine, of which you still must maintain recommended levels, is more efficient – you can save up to 70% in sanitizing chemical use.

- Remember to keep the recommended free residual of chlorine or bromine in the water as required in your specific region (Canada 3 to 5 ppm of chlorine or bromine).
- Made in the U.S.A (UL/CE/EPA Approved)



WORLD'S BEST BUILT SPAS